

1000 BIBLE COLORING PAGES

5-15 Minute Worksheets that Build Christian Faith!

DOT-TO-DOT **CUT, PASTE, & COLOR PUZZLES**
COLOR-BY-NUMBER **LEARN-TO-DRAW** **COLORING SHEETS**

PHOTOCOPY POLICY

You are allowed to make unlimited copies of the Printables enclosed for your private personal & church use.

You are not allowed to distribute to other churches (they must buy their own copy). You cannot photocopy the Printables and re-sell them. It is also illegal to translate this product for sale in other languages.

COPYRIGHT NOTICE

The material enclosed is copyrighted. You do not have resell rights or giveaway rights to the material provided herein. Only customers that have purchased this material are authorized to view it. If you think you may have an illegally distributed copy of this material, please contact us immediately.

No part of this publication may be reproduced or transmitted in any form or by any means, electronic or mechanical, including photocopying or by information storage and retrieval systems. It is illegal to copy this material and publish it on another web site, news group, forum, etc. even if you include the copyright notice.

LEGAL NOTICE

While all attempts have been made to verify information provided in this publication, neither the author nor the publisher assumes any responsibility for errors, omissions or contrary interpretation of the subject matter herein. The publisher wants to stress that the information contained herein may be subject to varying state and/or local laws or regulations. All users are advised to retain competent counsel to determine what state and / or local laws or regulations may apply to the user's particular operation. The purchaser or reader of this publication assumes responsibility for the use of these materials and information. Adherence to all applicable laws and regulations, federal, state and local, governing professional licensing, operation practices, and all other aspects of operation in the US or any other jurisdiction is the sole responsibility of the purchaser or reader. The publisher and author assume no responsibility or liability whatsoever on the behalf of any purchaser or reader of these materials. Any perceived slights of specific people or organizations is unintentional.

CONTENTS



Dot-2-Dot Drawings 5



Learn to Draw Step-by-Step 26



Cut 'n Paste Puzzles 47



Color by Numbers..... 68



Coloring Pages 89



Memory Verse Posters 113



INTRODUCTION: 100 BIBLE COLORING PAGES

Here's a way to get children interested in many Bible concepts, stories and heroes, using little else except a box of crayons! In our *Bible Coloring Pages*, we touch upon Bible tales from Creation to the Ascension as well as Bible principles, symbols, and memory verses. It's a hundred pages where children can color, count, connect and cut, and they will pick up lots of great information about our Faith!

While it all looks so simple—learning by coloring—this activity book has been designed by experts on kids, Christianity, and learning, to assure that every page has the capacity to teach something important. Consider it one of the best tools out there for sowing seeds of the faith to kids who just want to make art the easy way!

WHAT'S INCLUDED

Five wonderful coloring activities are included to keep little hands and minds busy for hours!

20 Dot-2-Dot Drawings: By following the numbers, children will draw the Star of David, Moses' staff, Christ's cross, and much more...

20 Learn to Draw Step-by-Step Illustrations: By following our illustrator's instructions, kids will draw the Alpha & Omega signs, easy angels, and a manger, among other important symbols.

20 Cut 'n Paste Puzzles: A pair of kiddie scissors will lose puzzle pieces from the page, so kids can figure out which famous Bible scene lies within them! Included are scenes from David winning against Goliath to Daniel winning against the lions.

20 Color by Number: Just by following the numbers, kids will create colorful masterpieces from Moses seeing the burning bush to Mary seeing the Angel Gabriel.

20 Coloring Pages: Help kids learn about the Bible's heroes and key faith facts with our coloring pages designed for kids of ALL ages.

BONUS: 20 Memory Verse Posters: Kids will be exposed to some of the scriptures most cherished by Christianity. In small poster format, these scripture pages can be posted on refrigerators, in bedrooms, or slipped into lunch bags.

DIFFERENT USES FOR THIS BOOK

The Bible Coloring and Activity Book has many great uses!

For Youth Ministries, it is a

- Grand Christmas gift for students;
- Excellent prize for Sunday school games and memorization competitions;
- Great fund raiser;
- Excellent source for tear-out sheets for at the end or beginning of Sunday school.

For Parents, it can

- Be great for long rides in the car;
- Fill long waits, such as the dentist or pediatrician's office;
- Serve as a fun Christmas gift;
- Work well with home schooling curricula for younger students;
- Generate lots of conversation at home when kids ask questions about what things mean...

And much more! Use this book to sow seeds of faith as kids have fun, coloring and learning, for hours!

DOT-2-DOT DRAWINGS

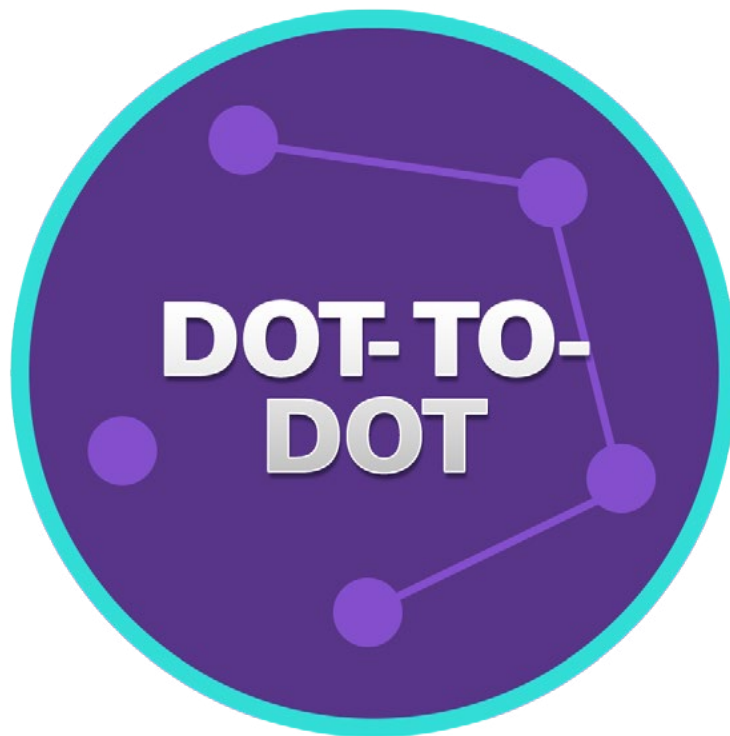

Connect the Dots!

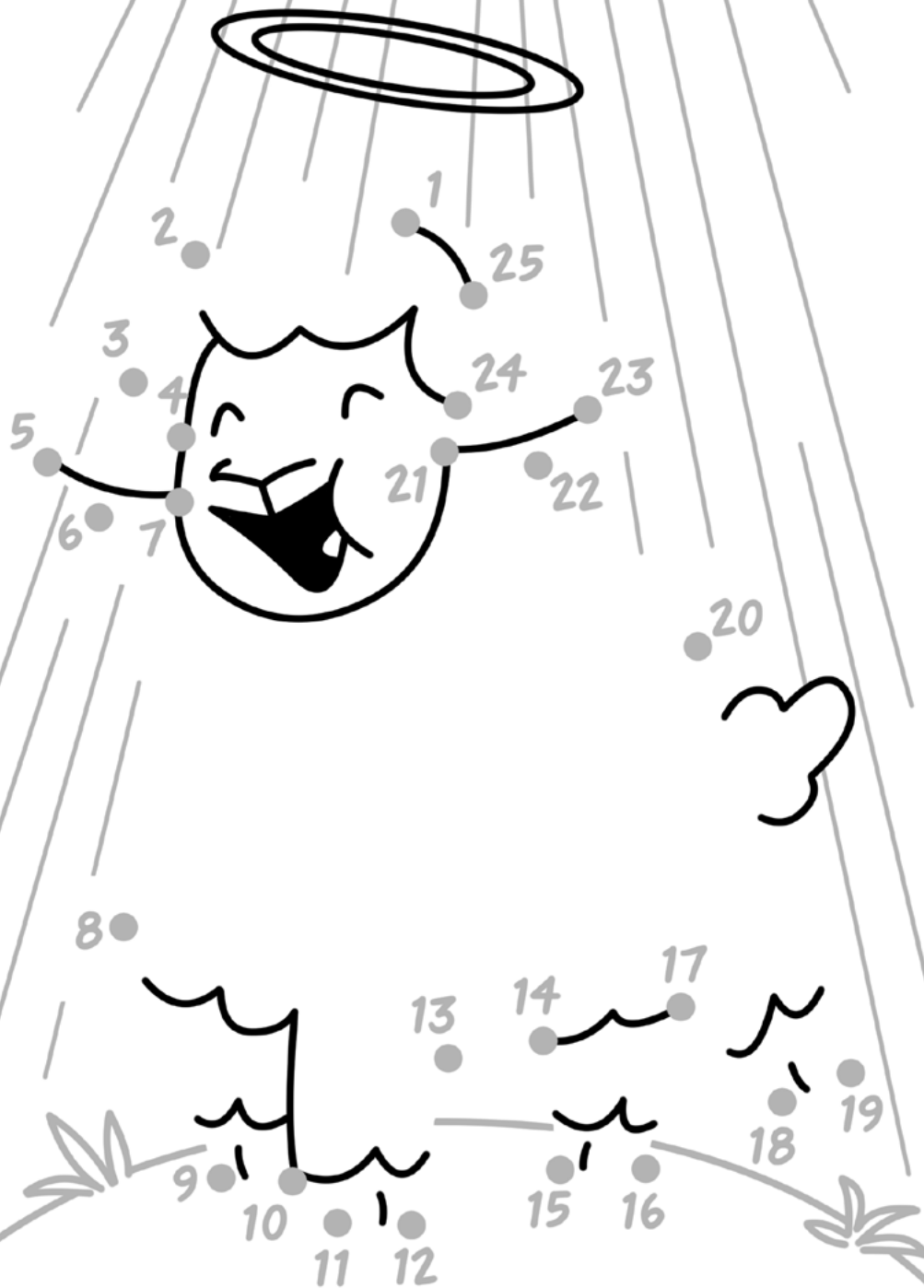

Jesus is the Lamb of God

Connect the Dots!

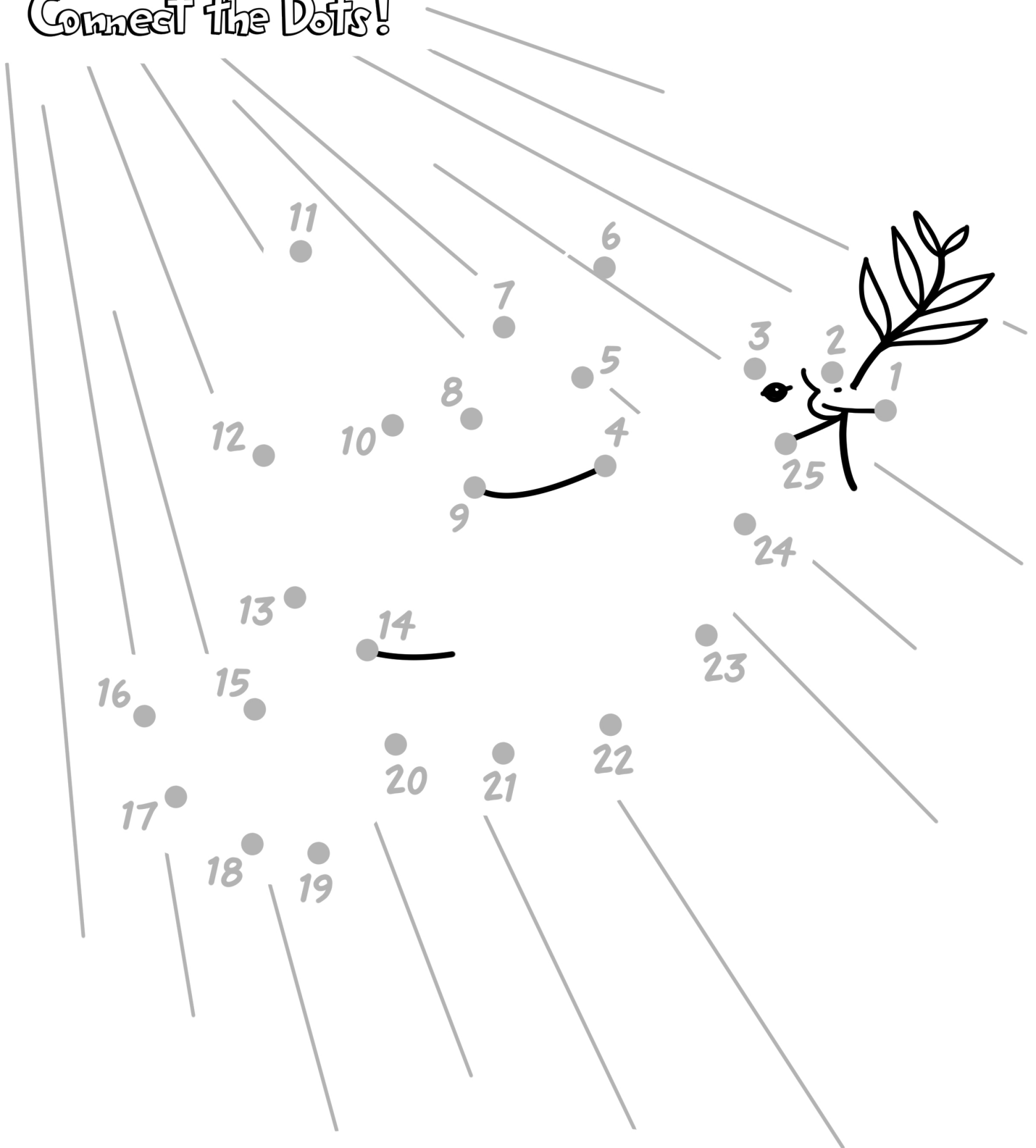

The Holy Spirit came
down on Jesus as a dove

Connect the Dots!

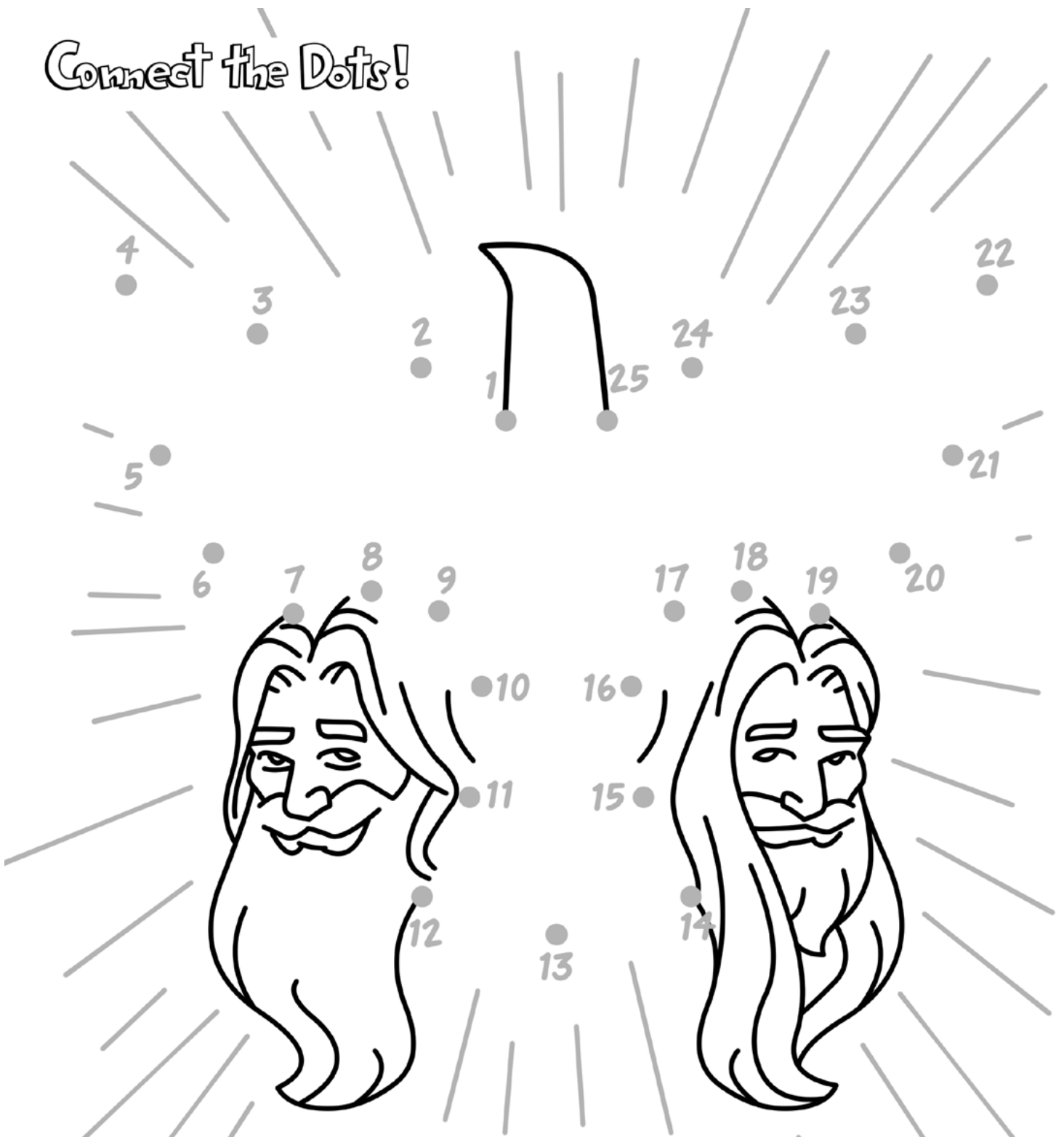

The trinity is
the Father, Son,
and Holy Spirit

Connect the Dots!

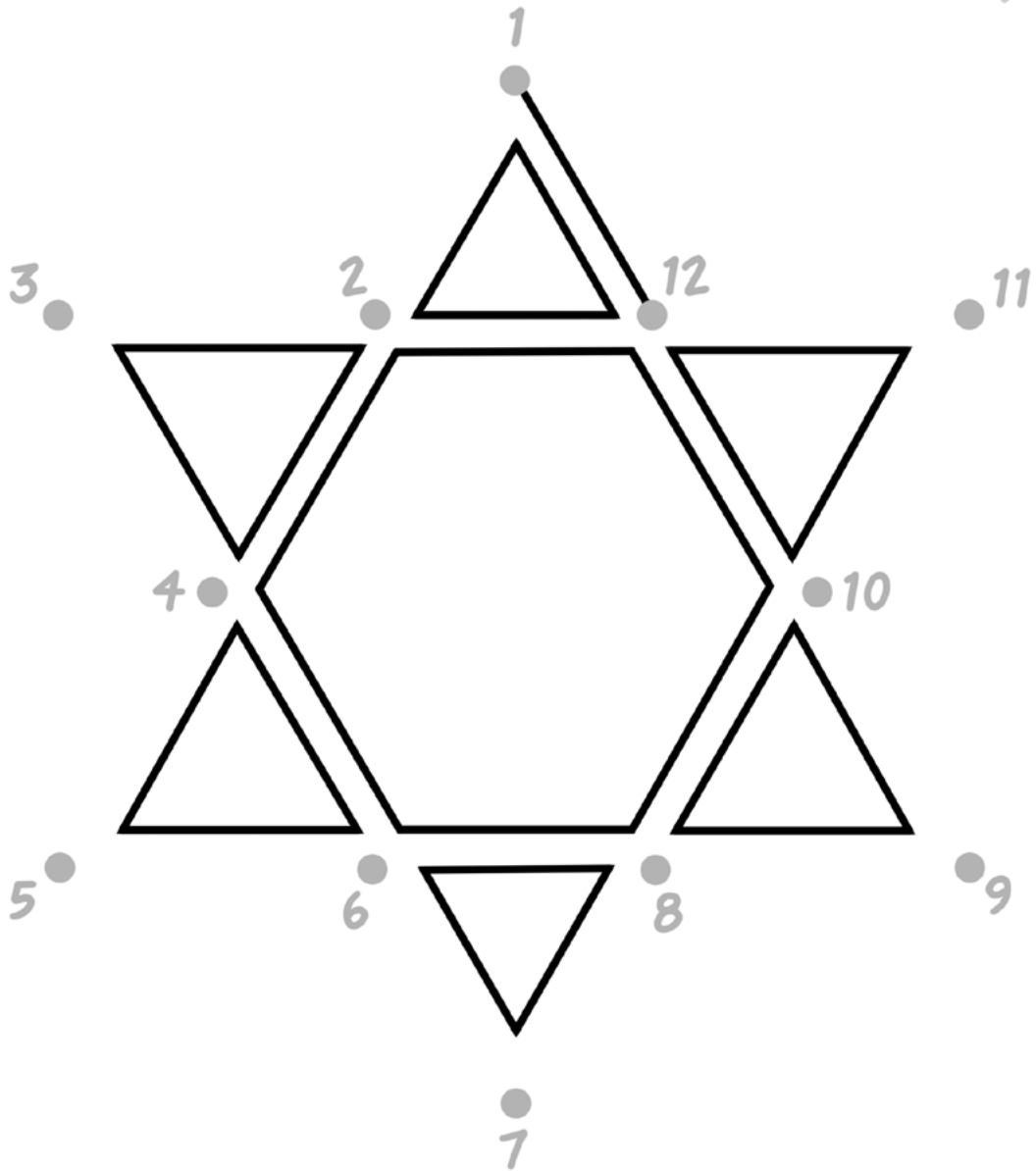

The star of David

Connect the Dots!

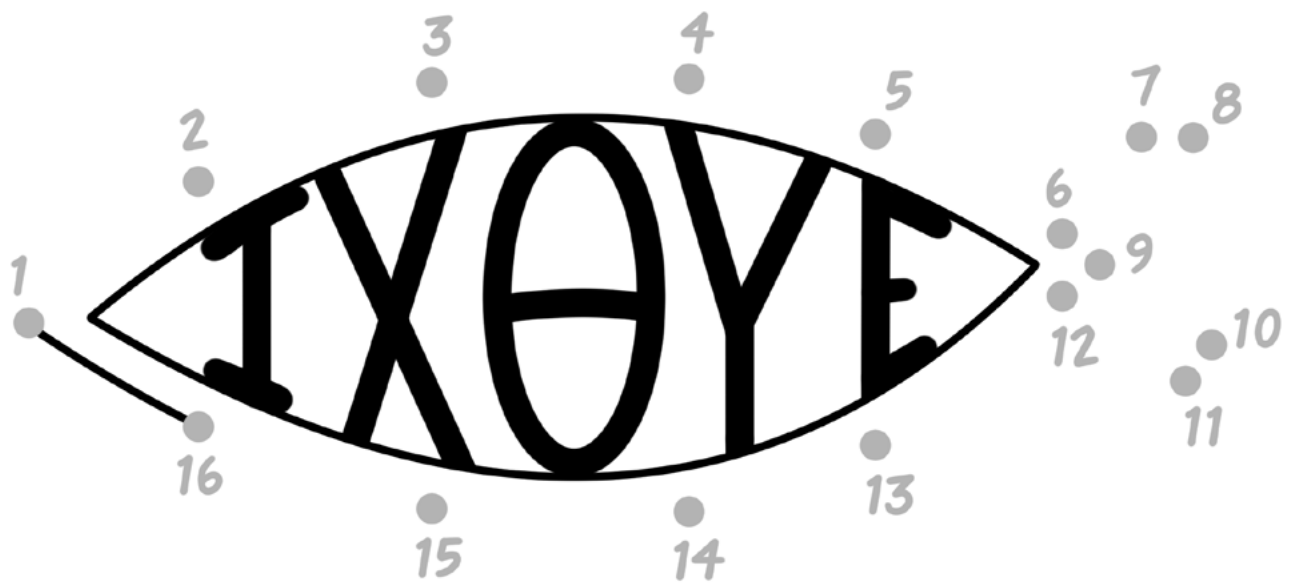

A fish is a symbol
of Christianity

Connect the Dots!



God came to Moses
at the burning bush

Connect the Dots!



God gave Moses a magic staff

Connect the Dots!



Joshua blew his horn to
take down the walls of Jericho

Connect the Dots!

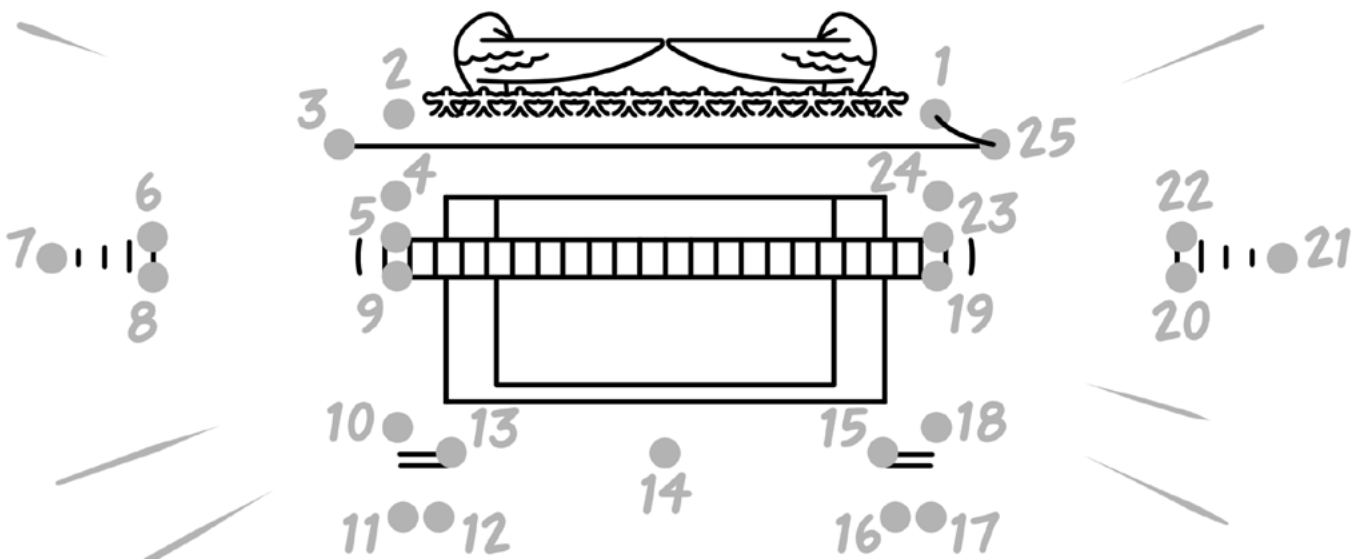
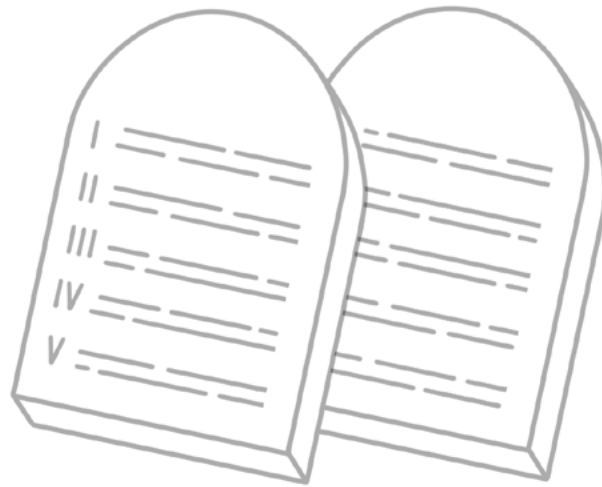

The Ark of the Covenant
holds The Ten Commandments

Connect the Dots!

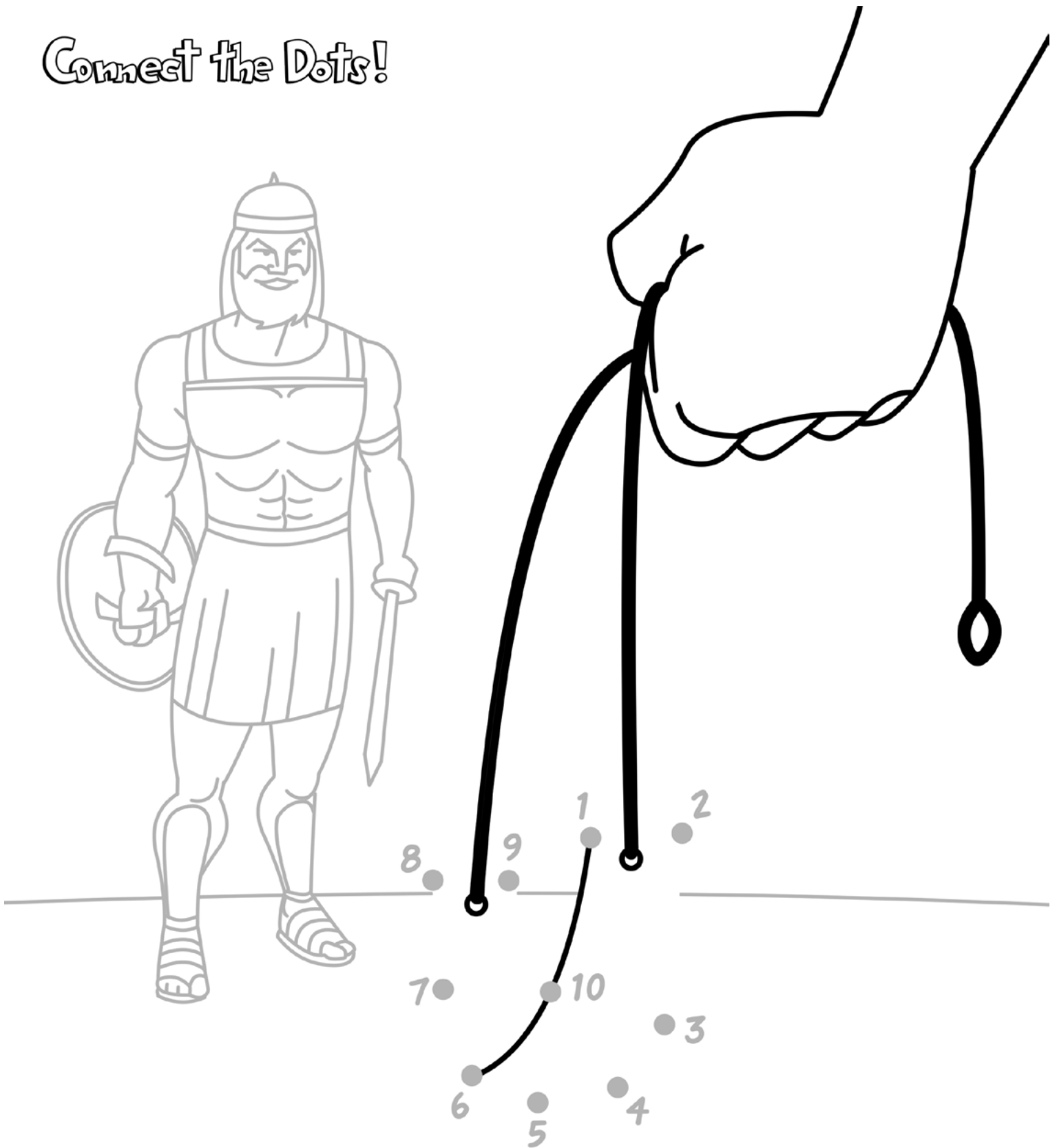

David used this to kill Goliath

Connect the Dots!



Solomon's temple was
the first temple built for God

Connect the Dots!

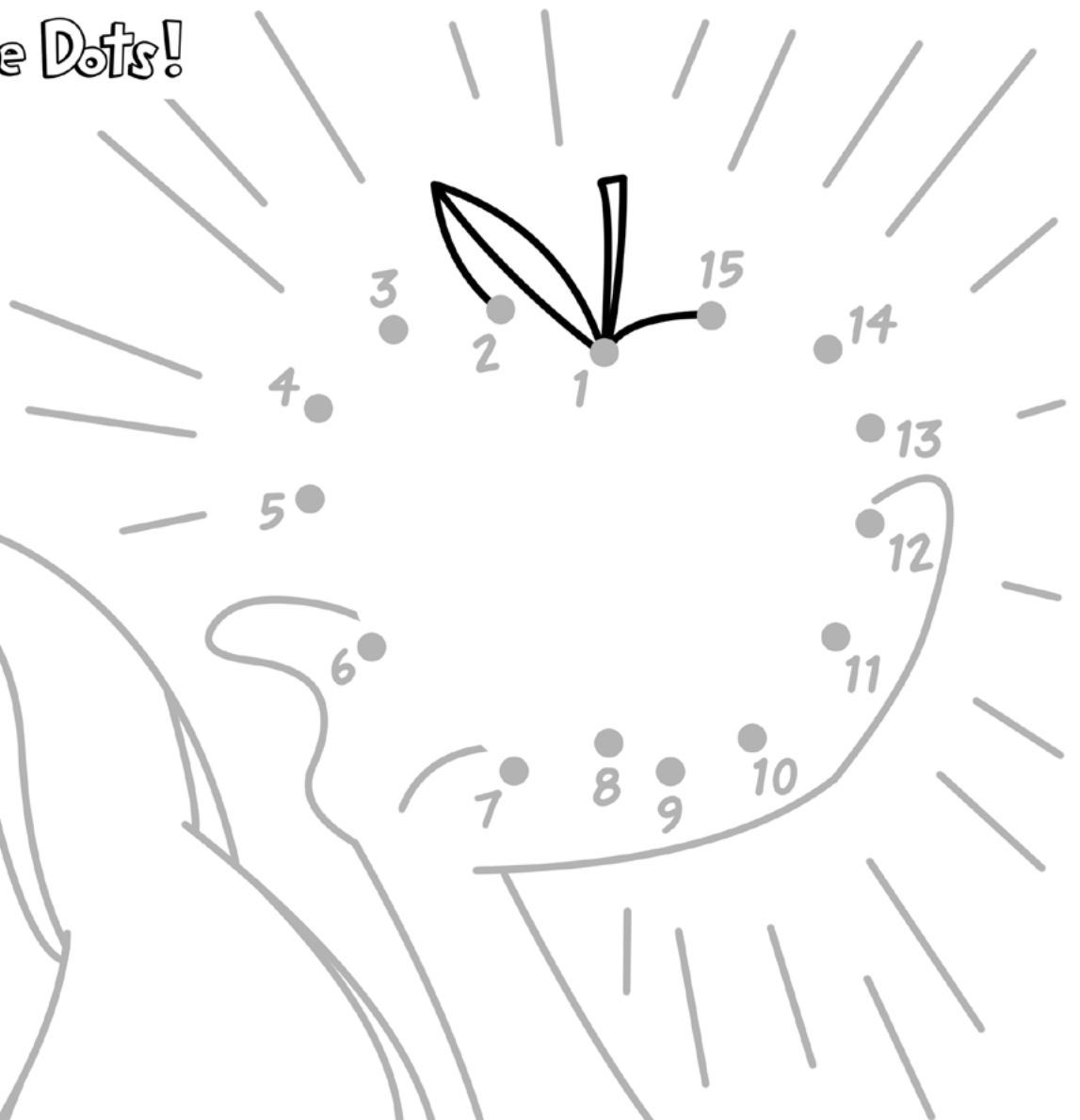

In the garden of Eden,
Eve ate the fruit

Connect the Dots!

We will bless God
on our instruments



Connect the Dots!

We will bless God with singing

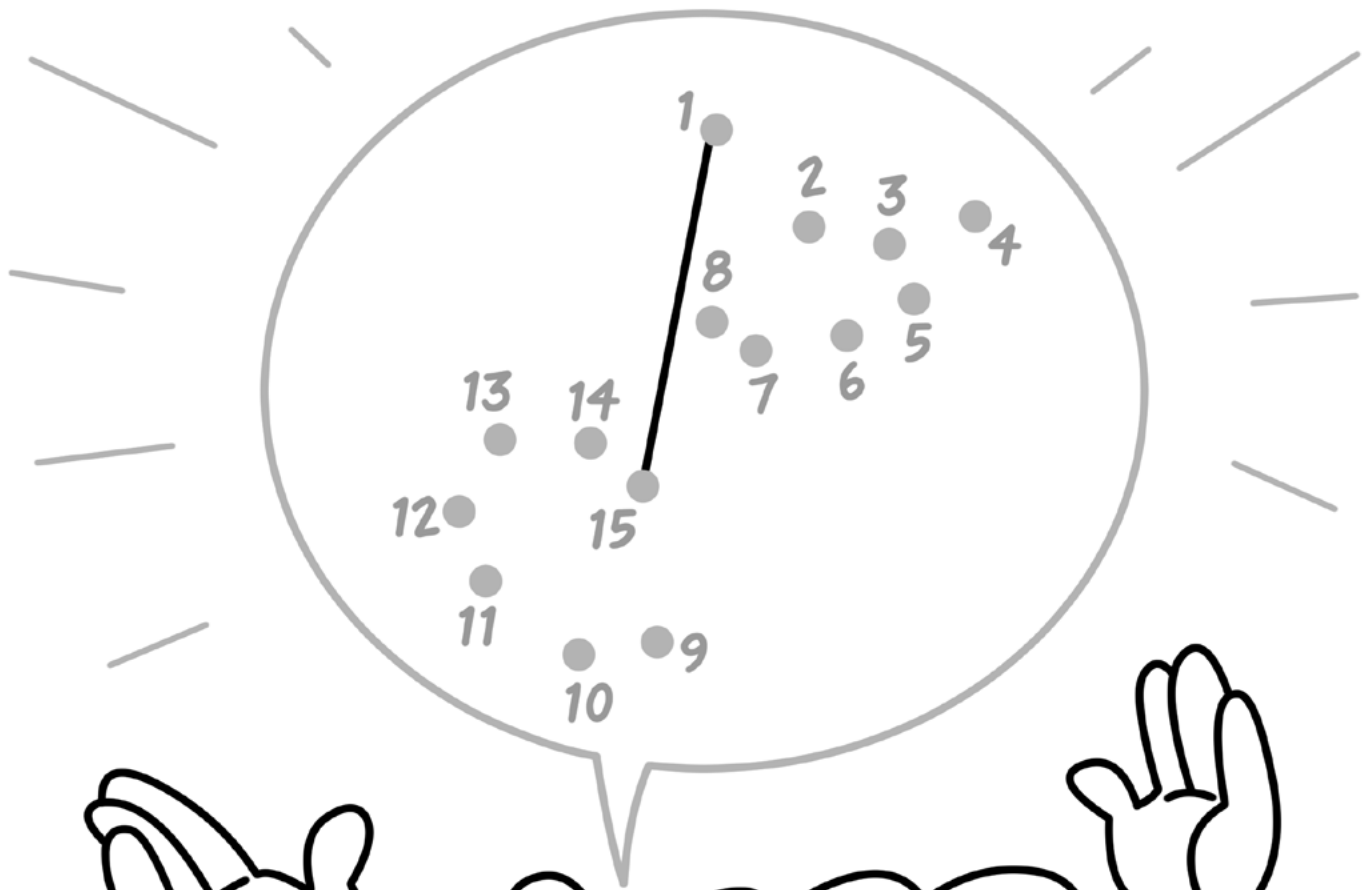

Connect the Dots!

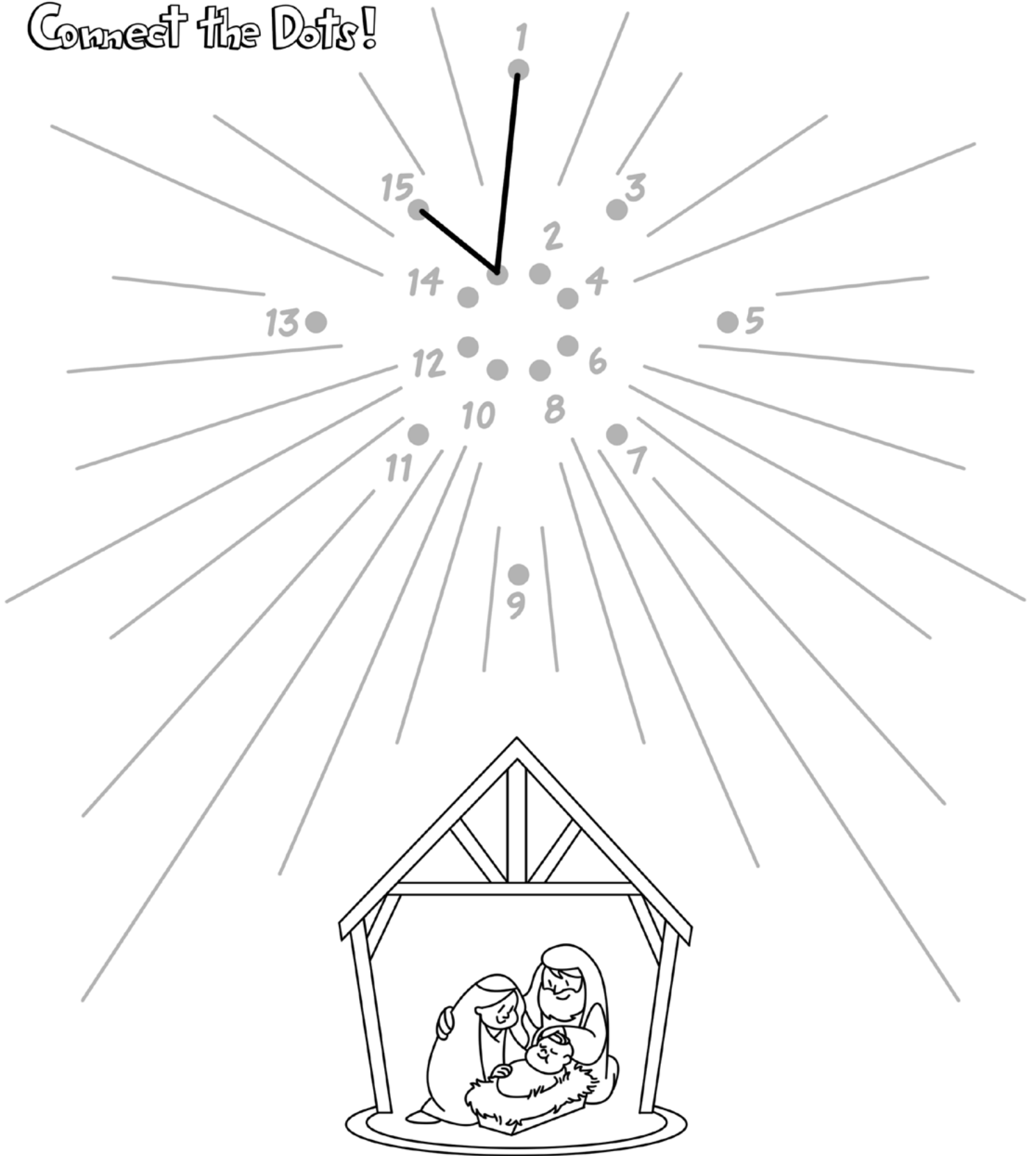

This burned over the sky
above where Jesus was born

Connect the Dots!

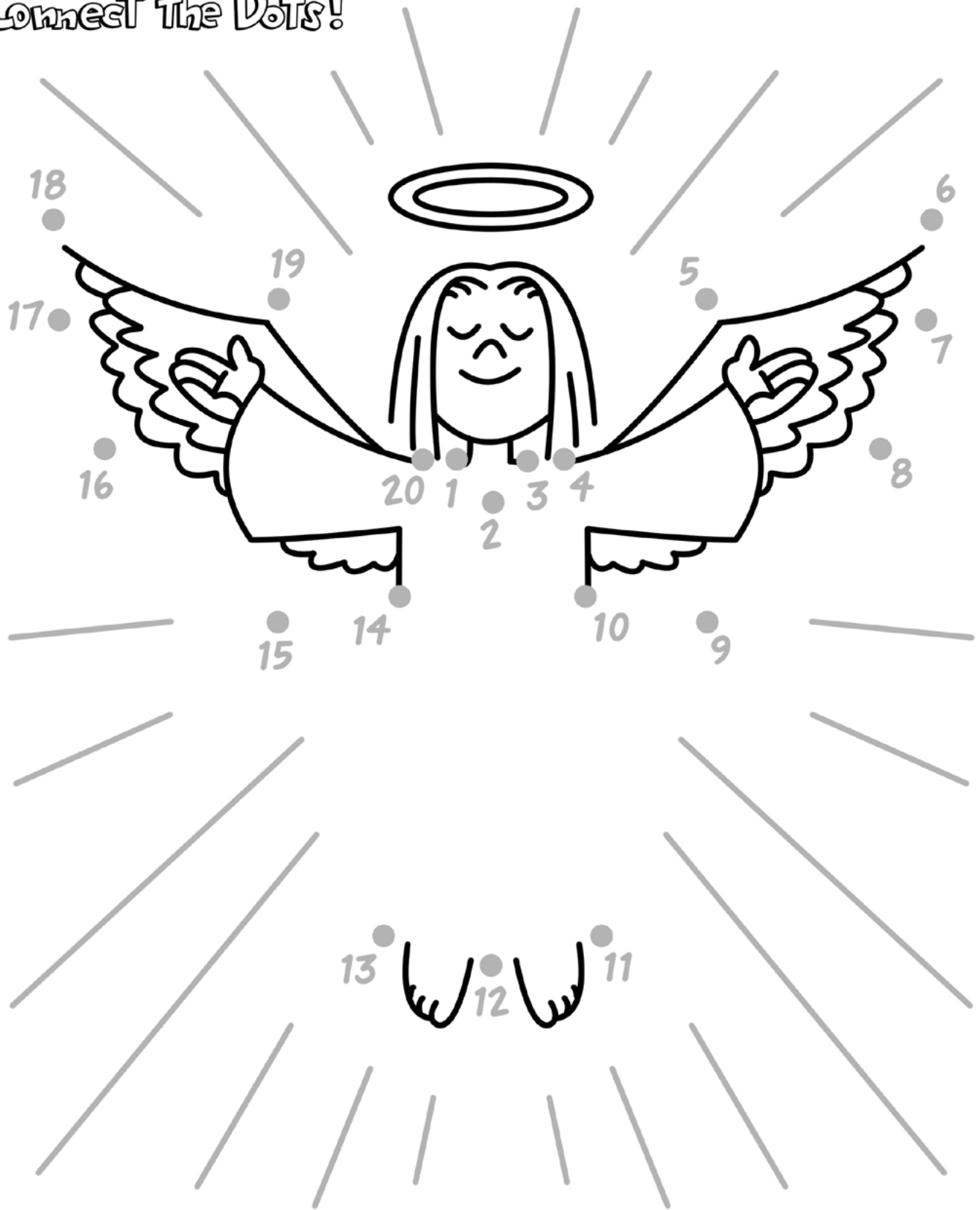

Angels give us God's messages

Connect the Dots!

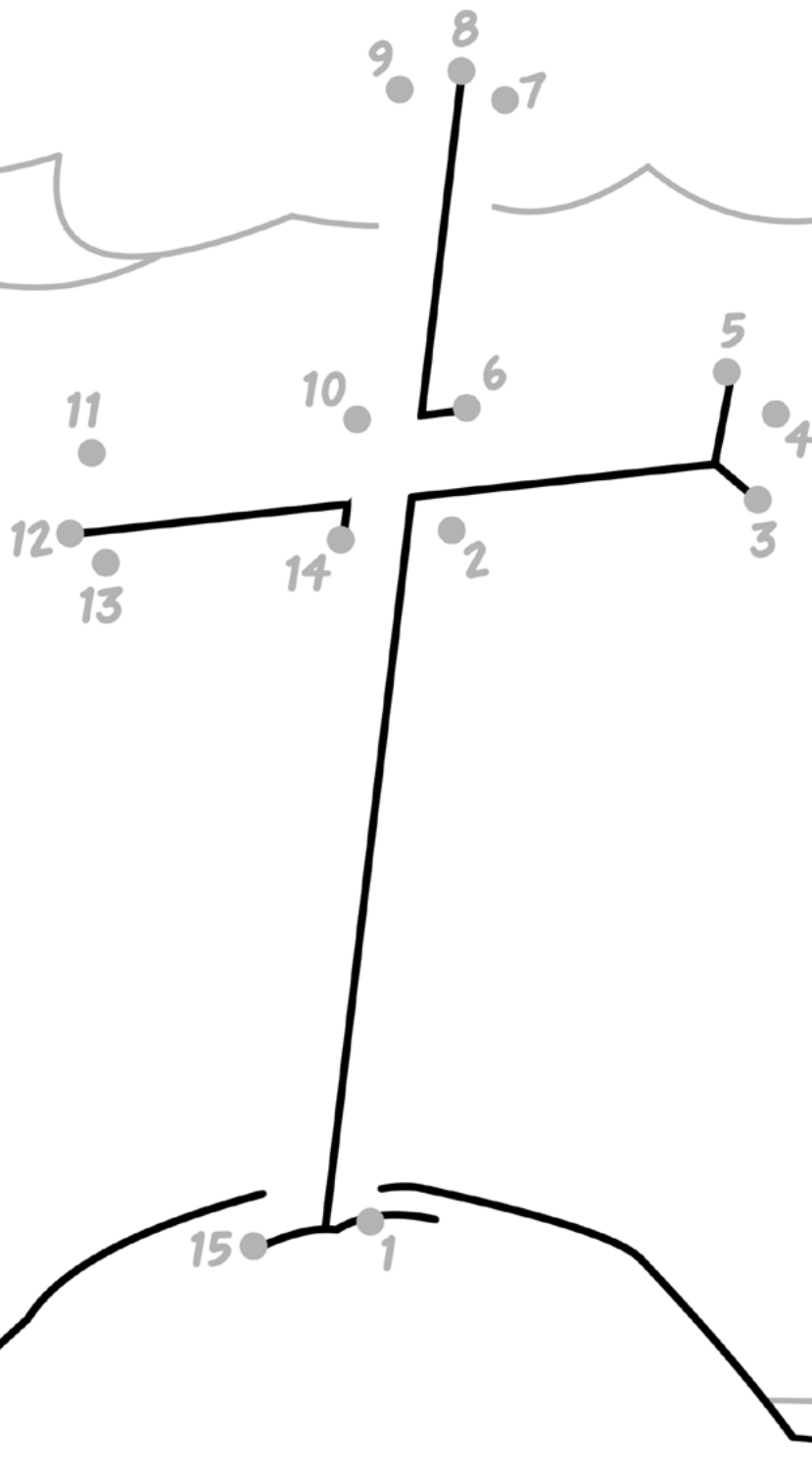

Jesus died on the cross for us

Connect the Dots!

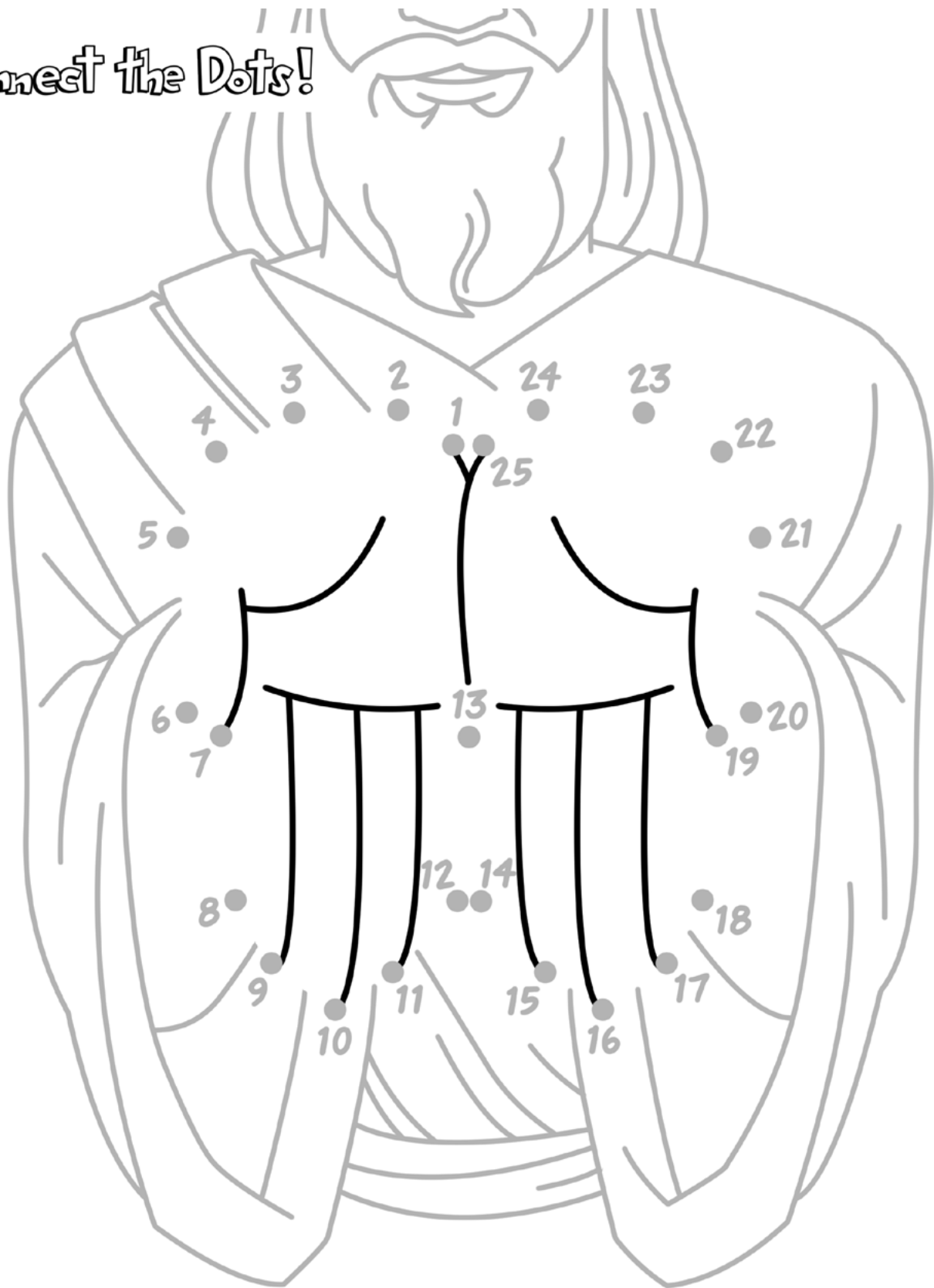

Jesus' hands
healed many people

Connect the Dots!



On Palm Sunday, we wave these

LEARN TO DRAW STEP-BY-STEP



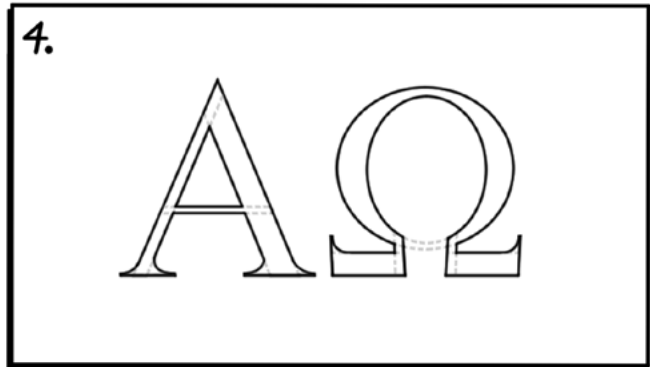
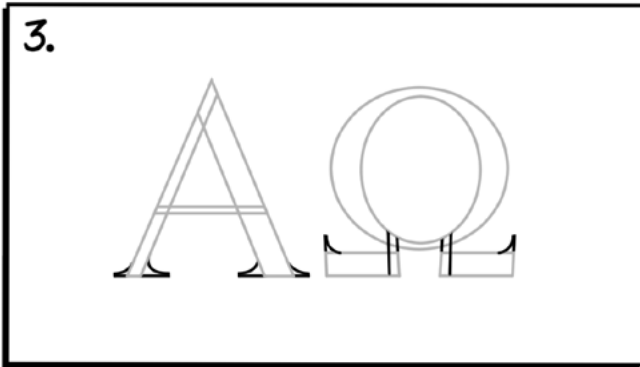
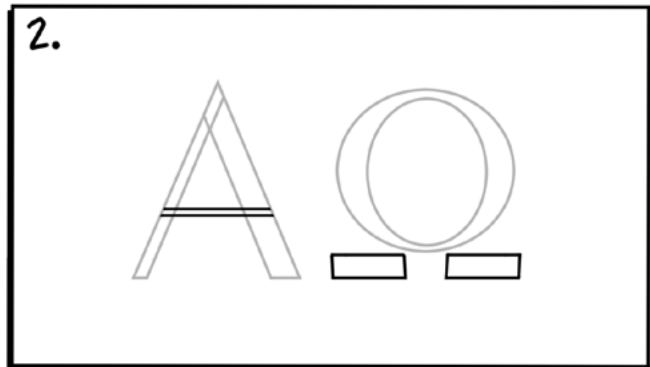
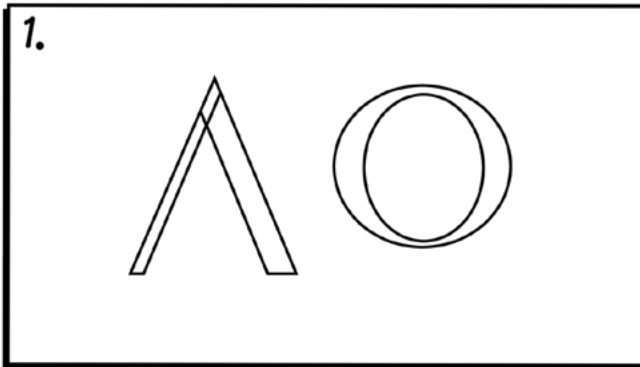

Jesus said "I am the Alpha and the Omega." - Revelation 1:8

Now it's Your turn!

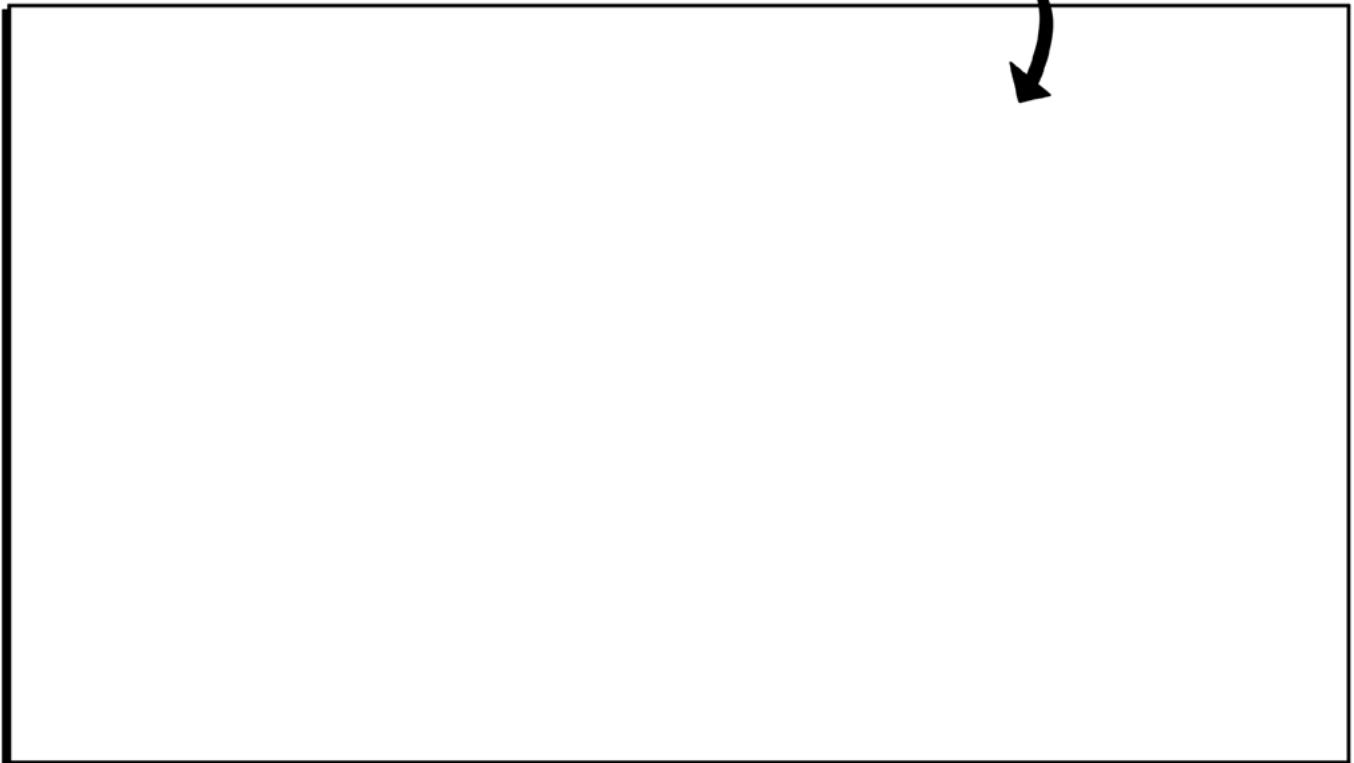

Learn to Draw...

ANGEL

Use a pencil,
Erase LINE after step 4

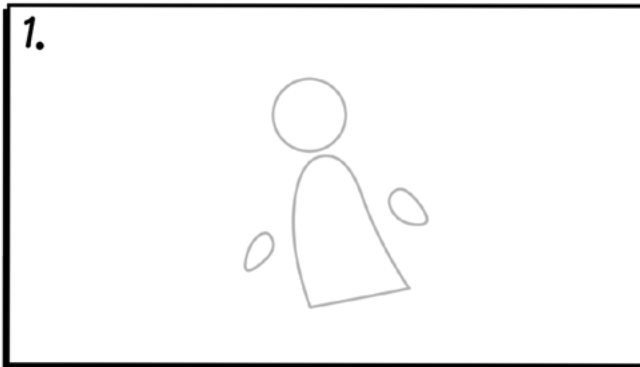

He will put his angels in charge of you, to guard you in all your ways - Psalm 91:11

Now it's Your turn!

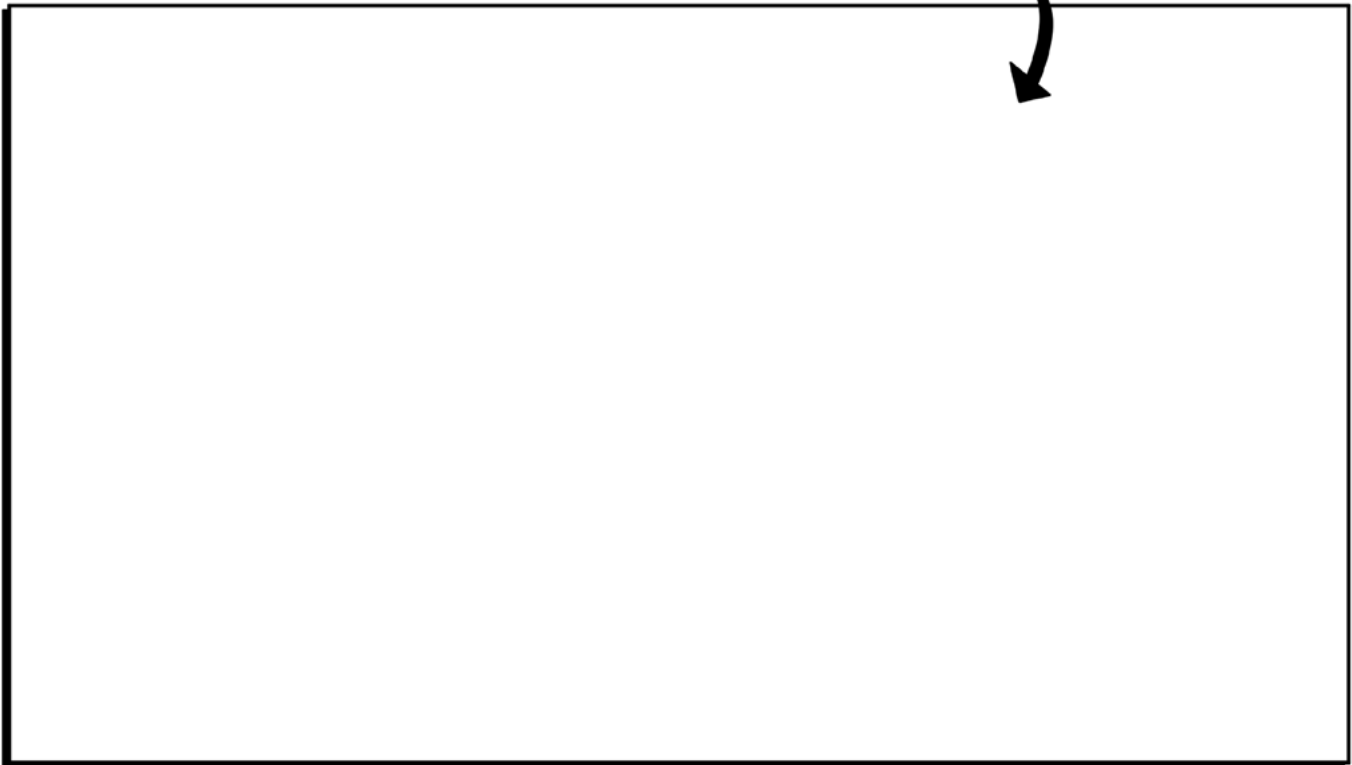

Learn to Draw...

CROSS

Use a pencil,
Erase LINE after step 4

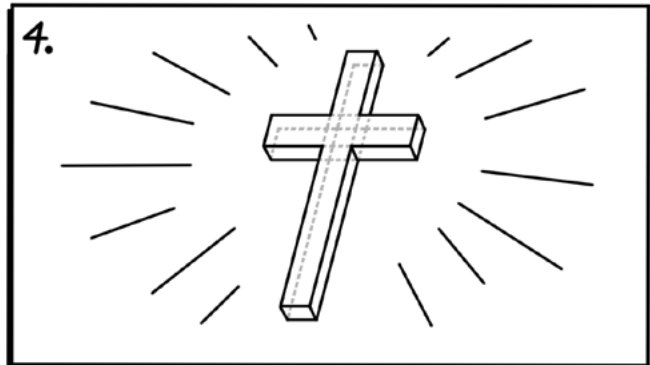
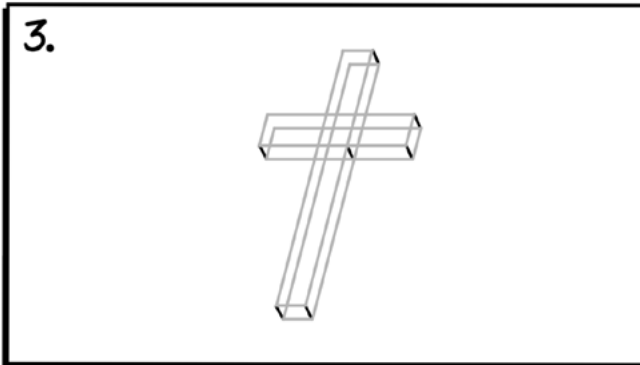
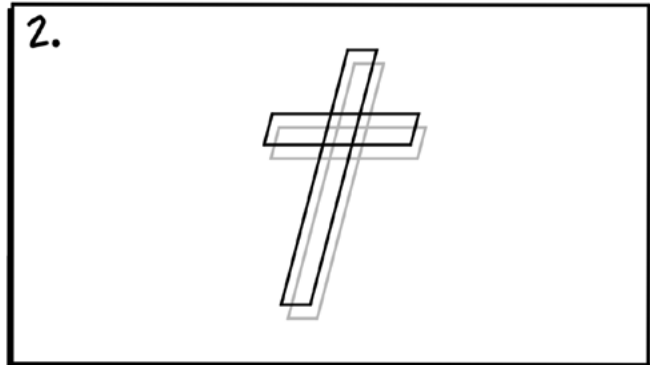
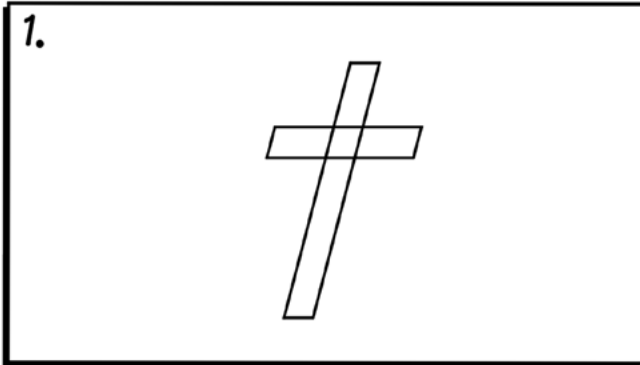

Jesus died on the cross and rose again

Now it's Your turn!

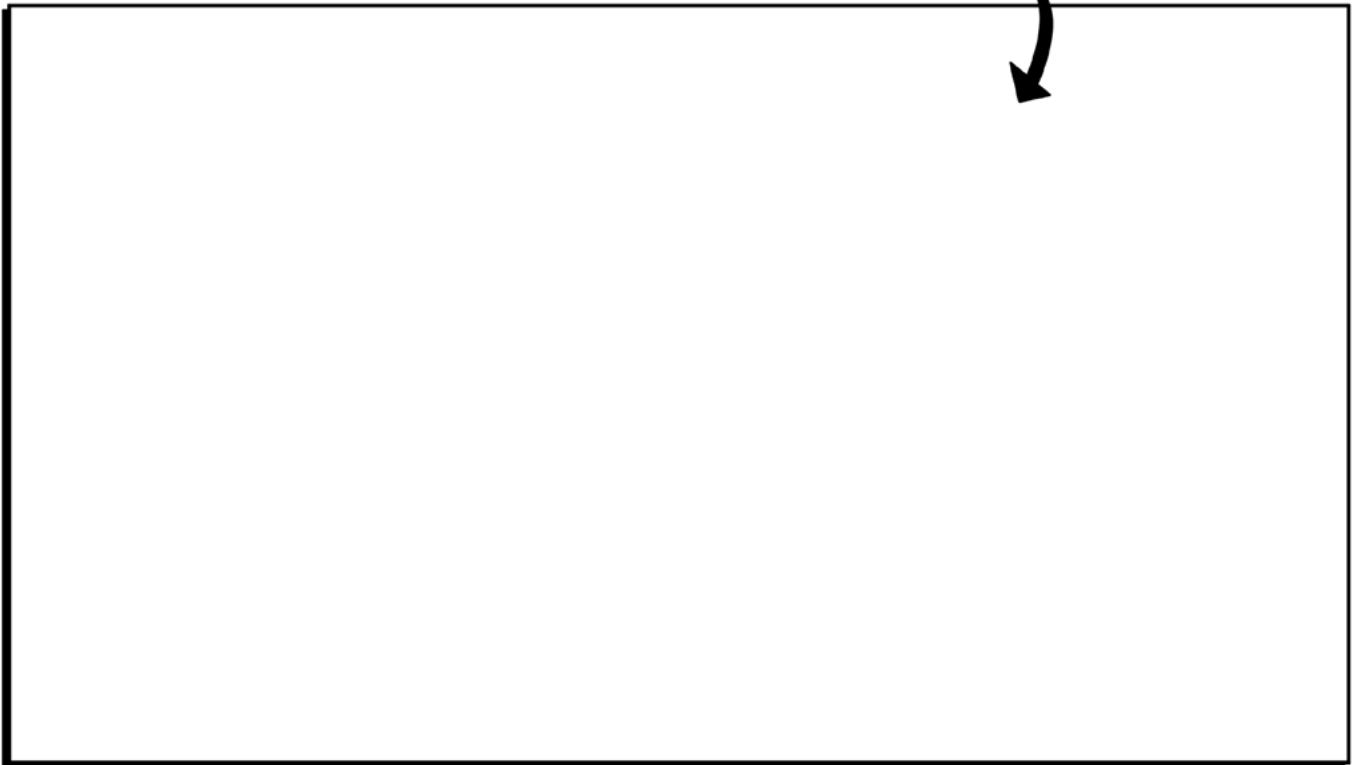

Learn to Draw...

BIBLE

Use a pencil,
Erase LINE after step 4

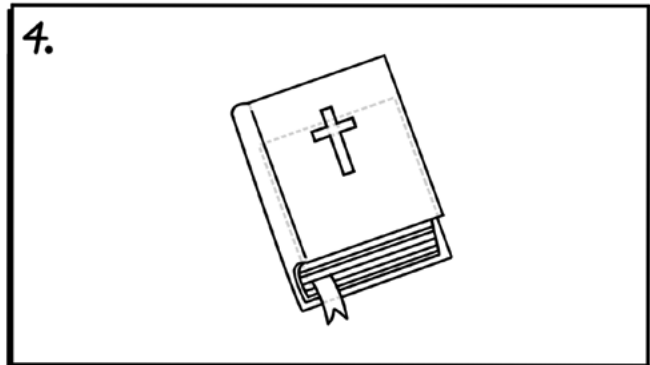
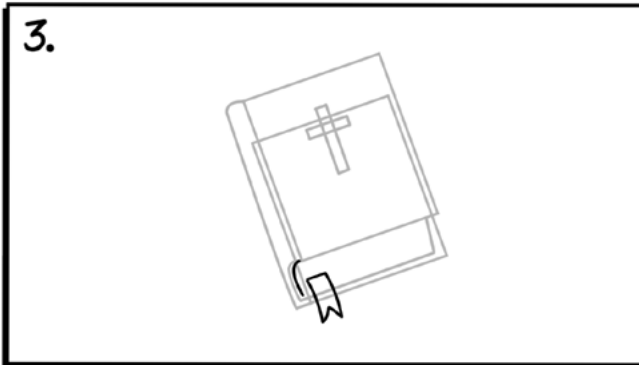
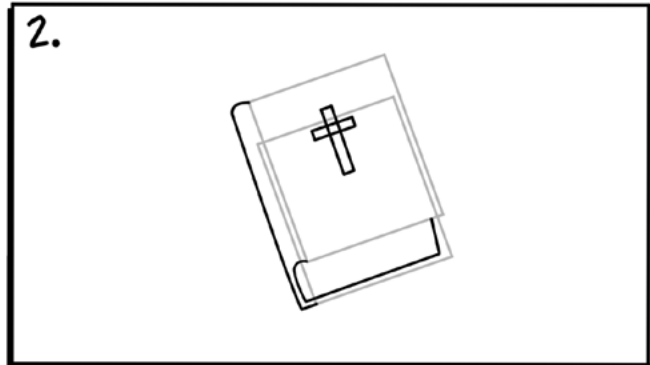
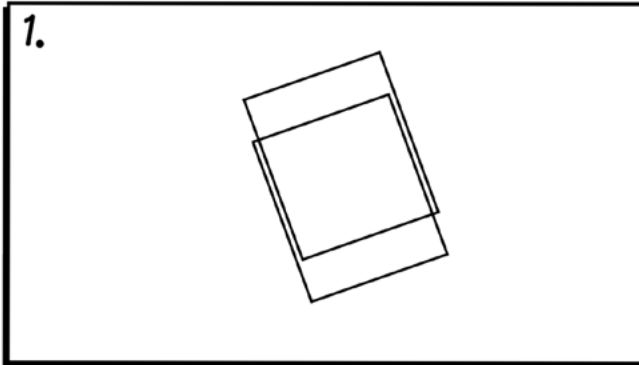

The bible tells us about God's love

Now it's Your turn!

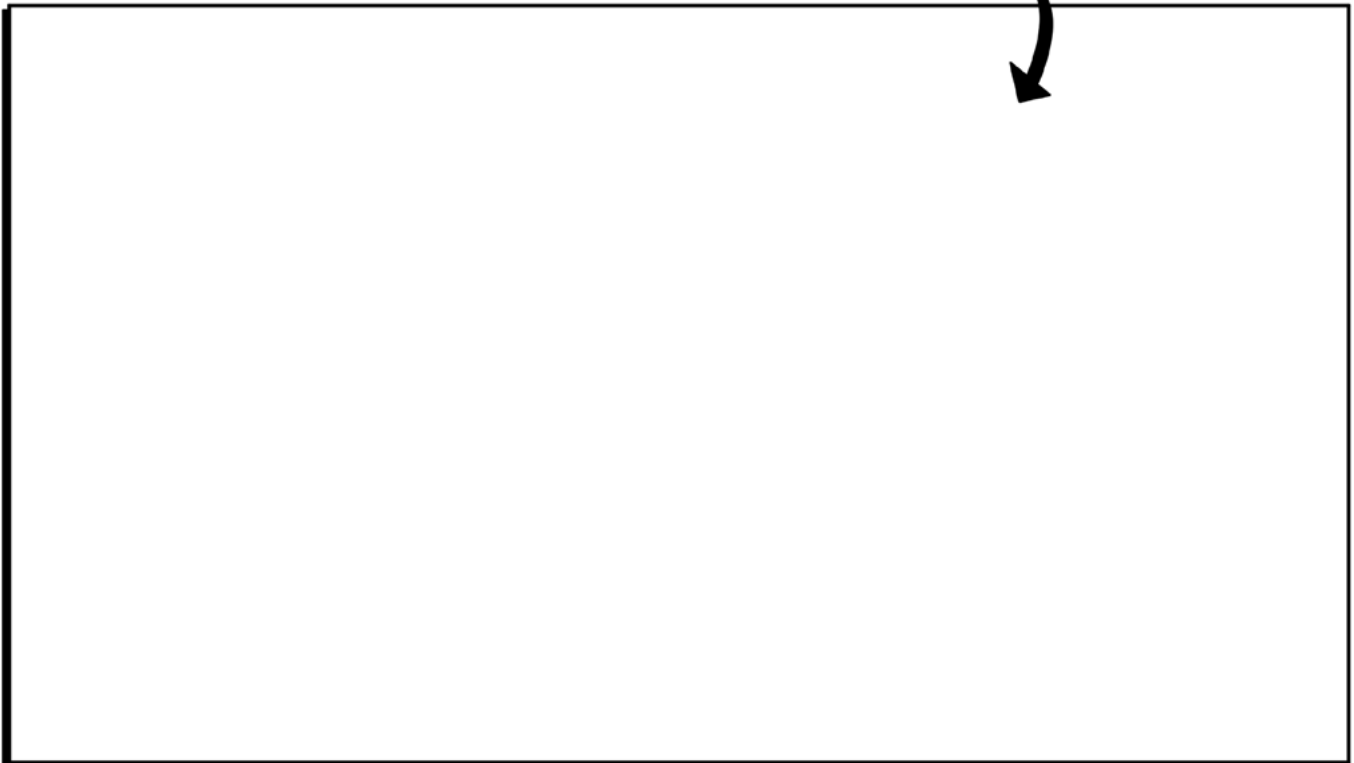

Learn to Draw...

STAR

Use a pencil,
Erase LINE after step 4

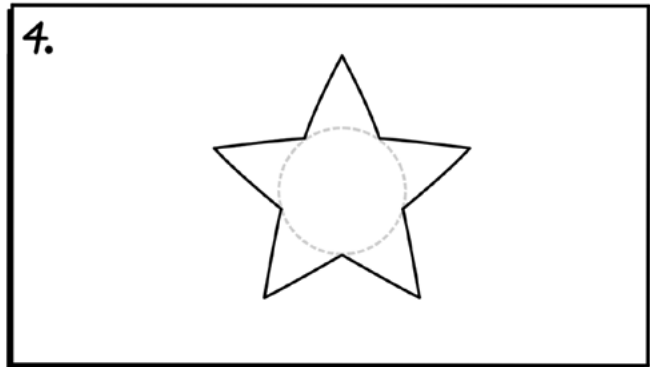
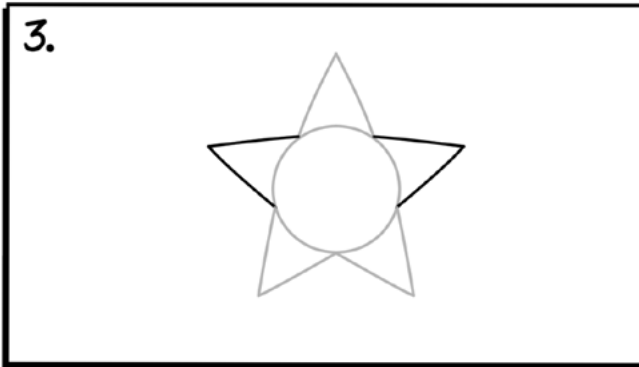
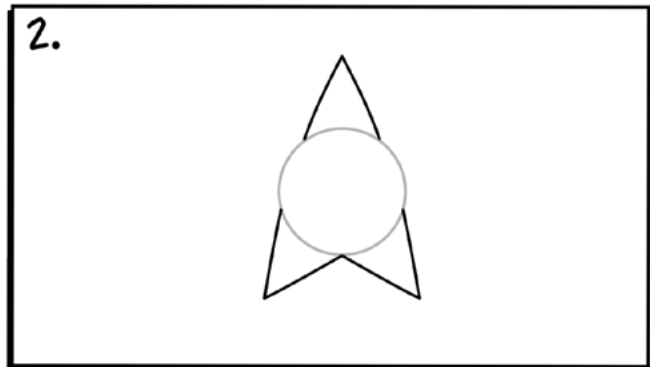
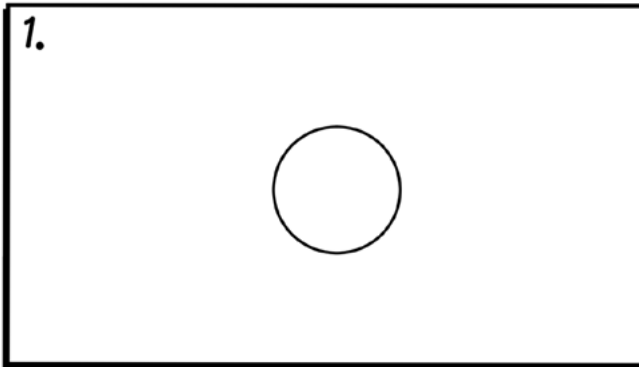

God determines the number of stars - Psalm 147:4

Now it's Your turn!

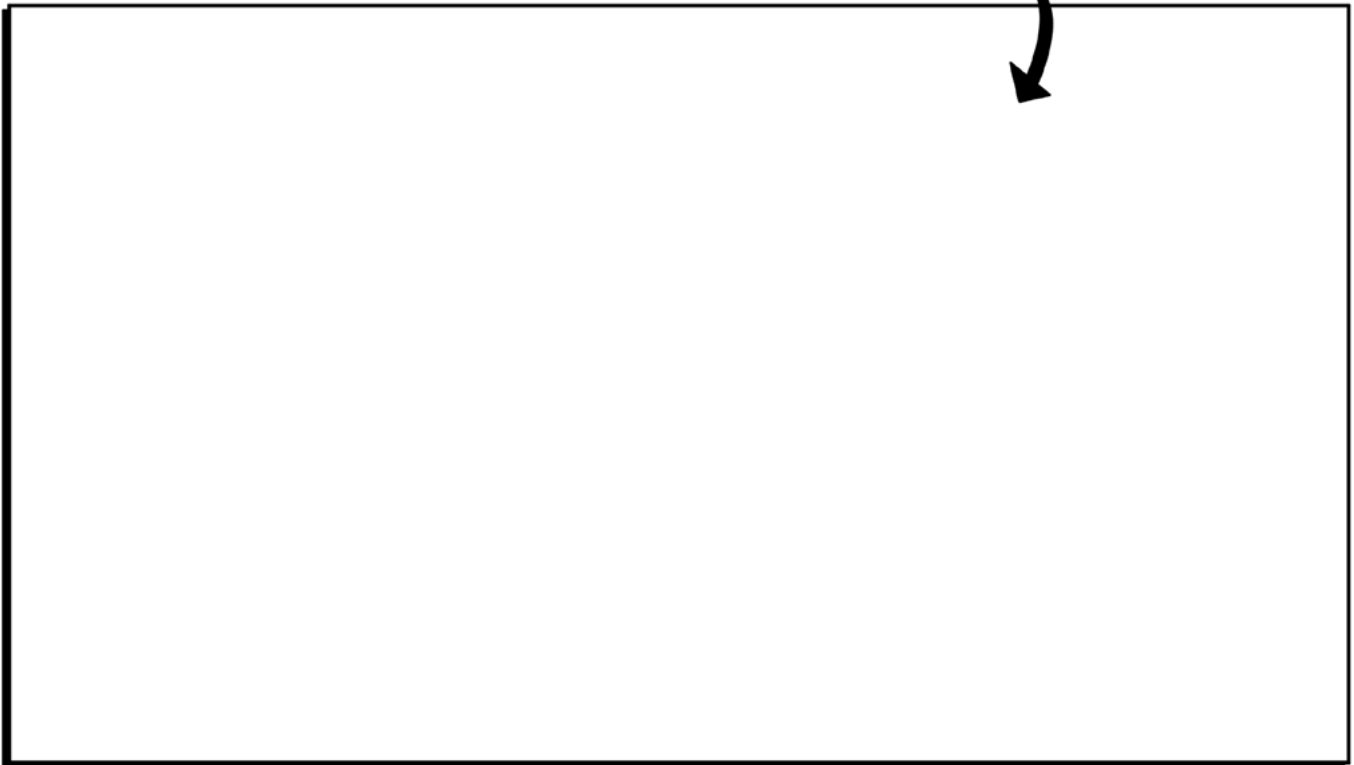

Learn to Draw...

GUITAR

Use a pencil,
Erase LINE after step 4

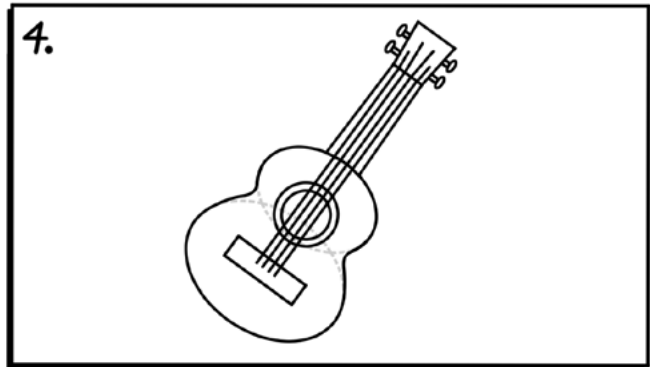
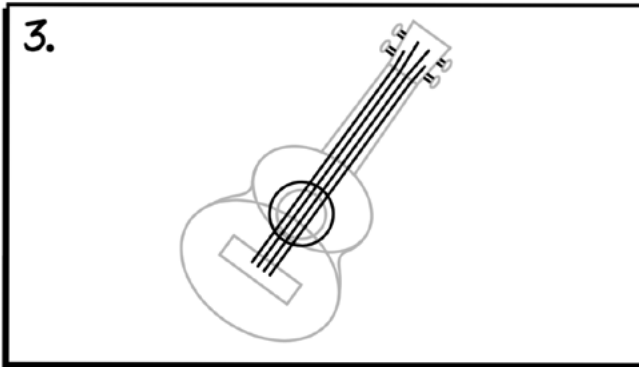
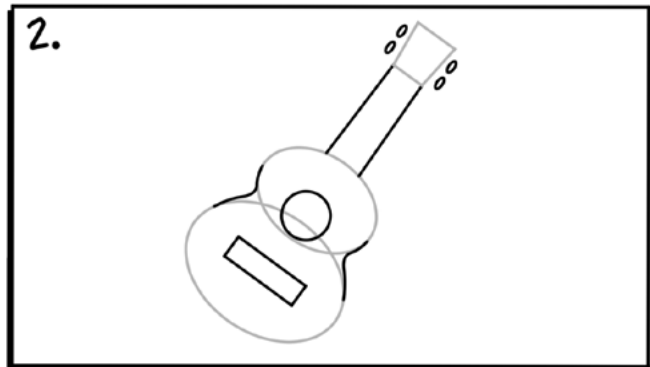
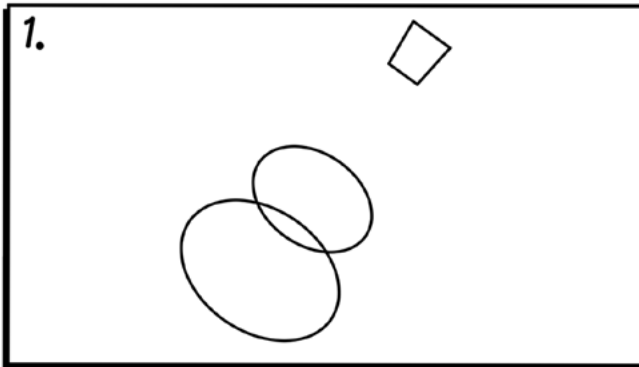

Praise God on stringed instruments - Psalm 150

Now it's Your turn!

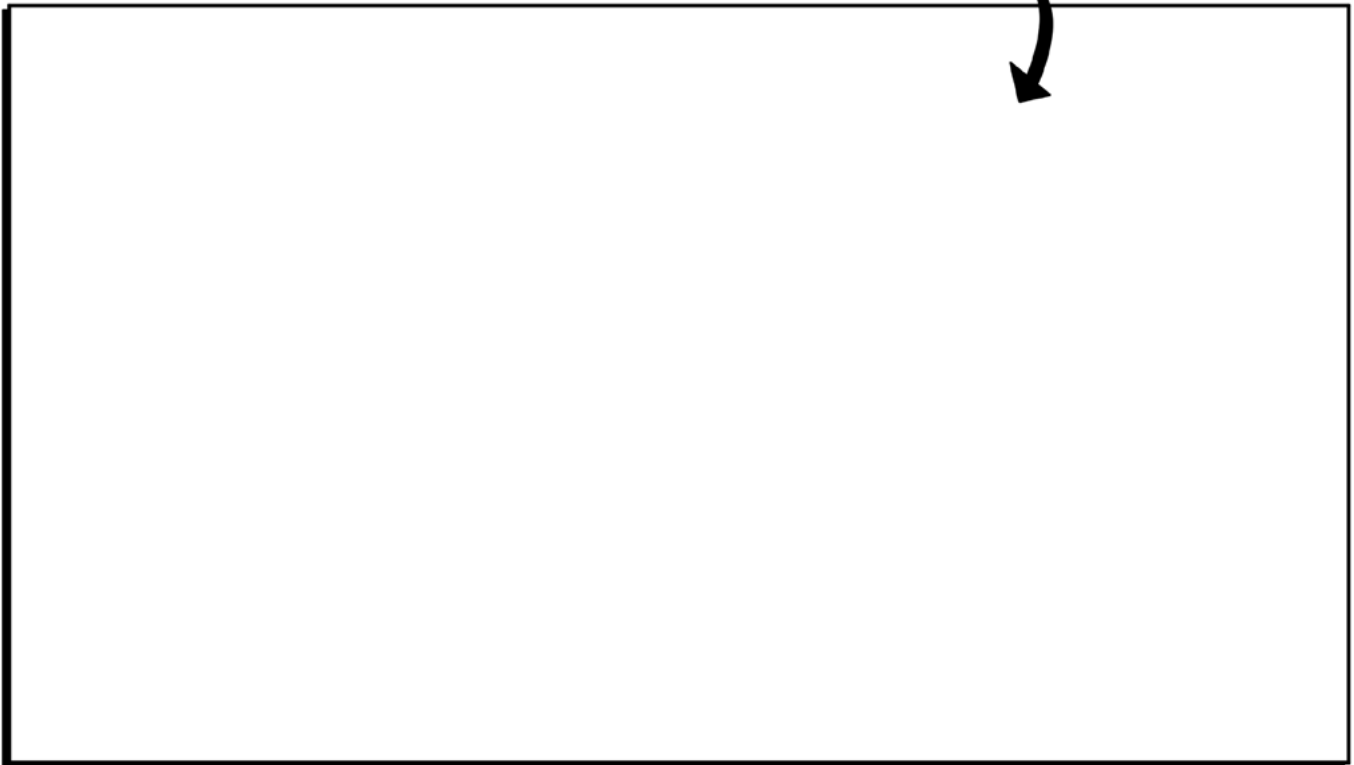

Learn to Draw...

CUP

Use a pencil,
Erase LINE after step 4

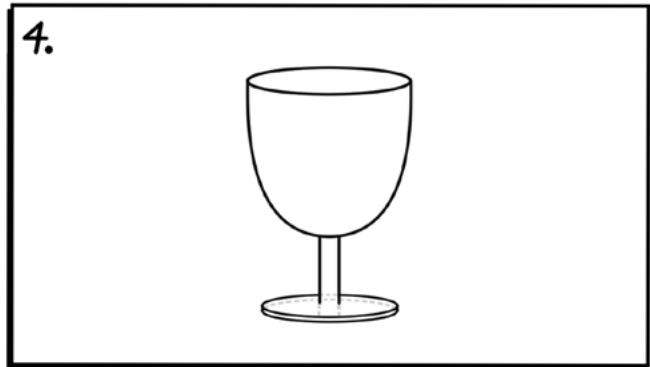
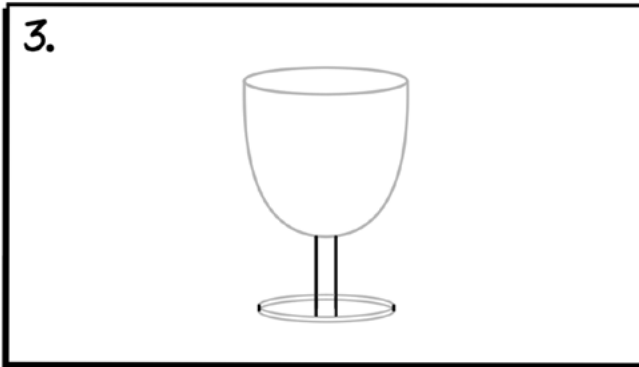
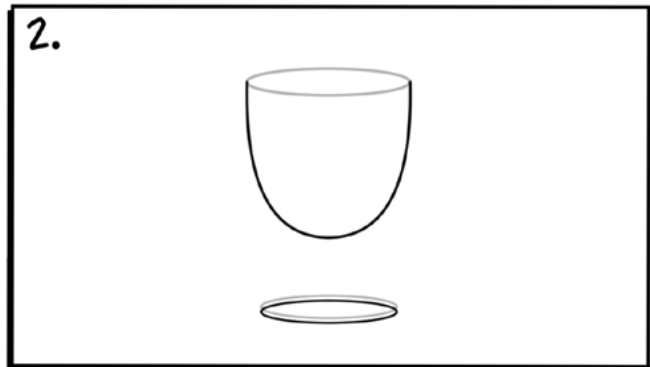
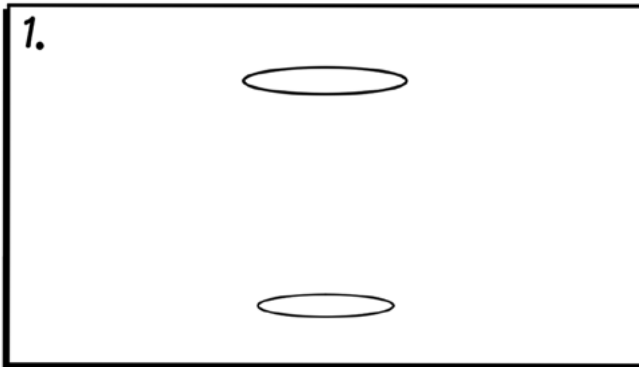

My cup runneth over - Psalm 23

Now it's Your turn!

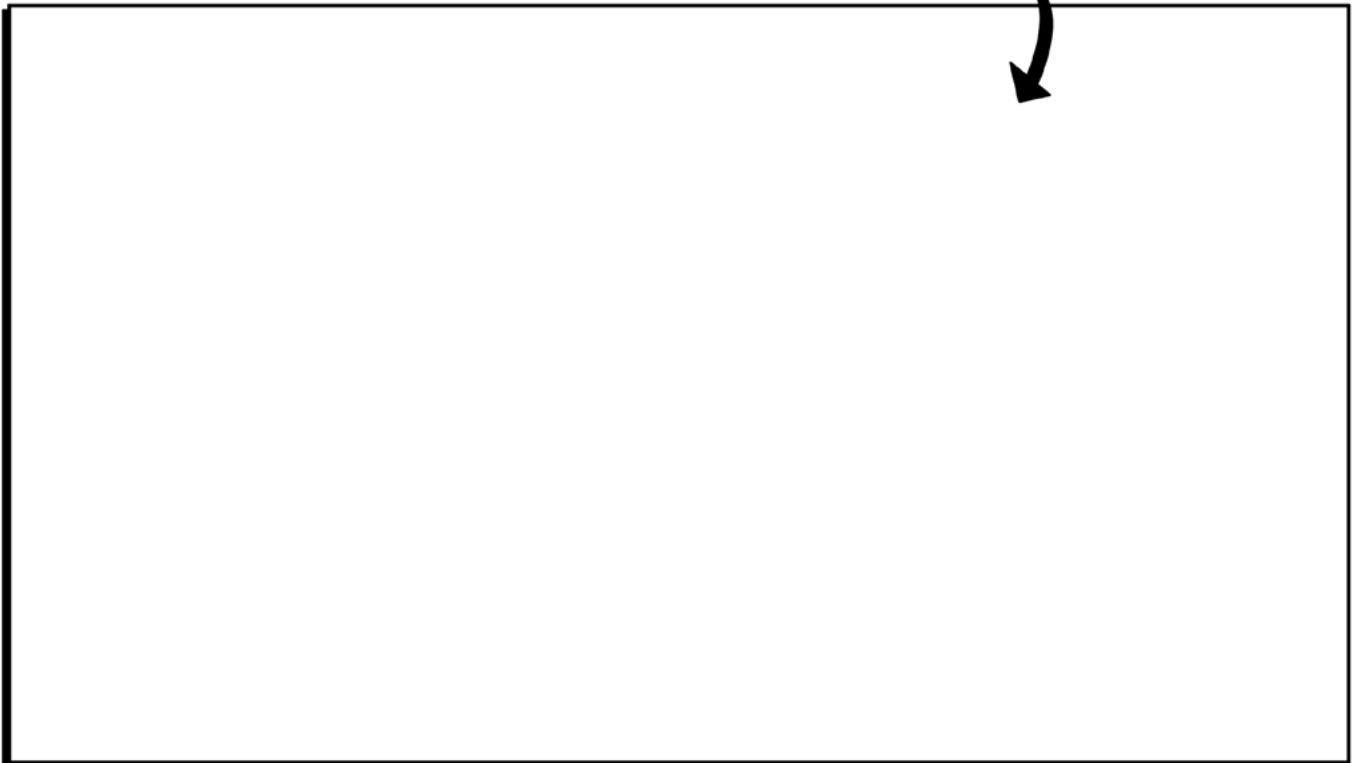

MANGER

Use a pencil,
Erase LINE after step 4

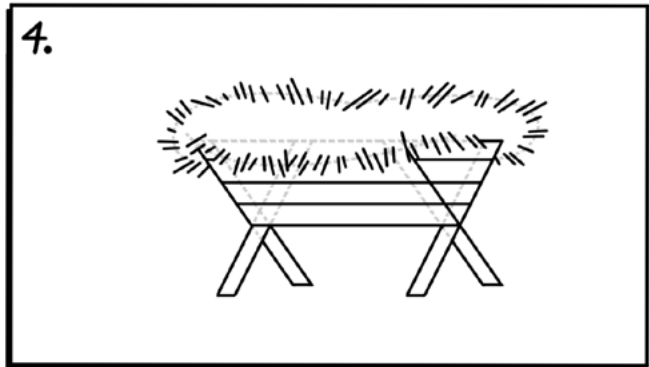
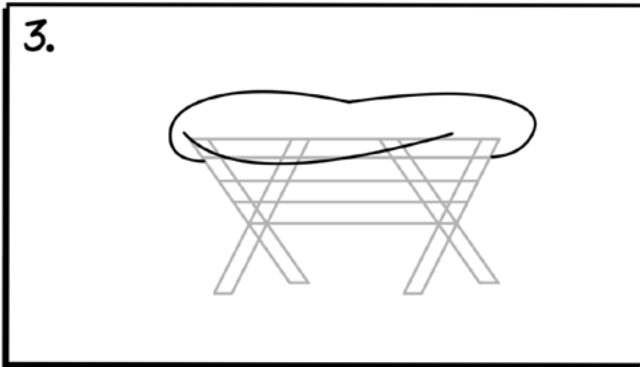
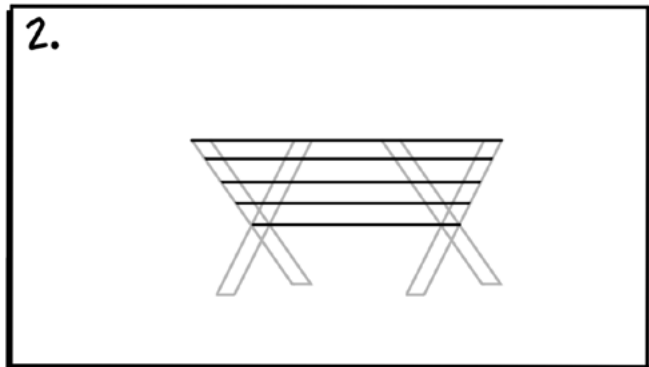
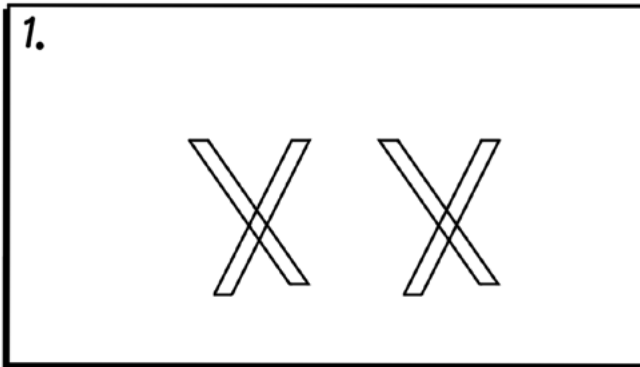

Jesus was born in a manger

Now it's Your turn!

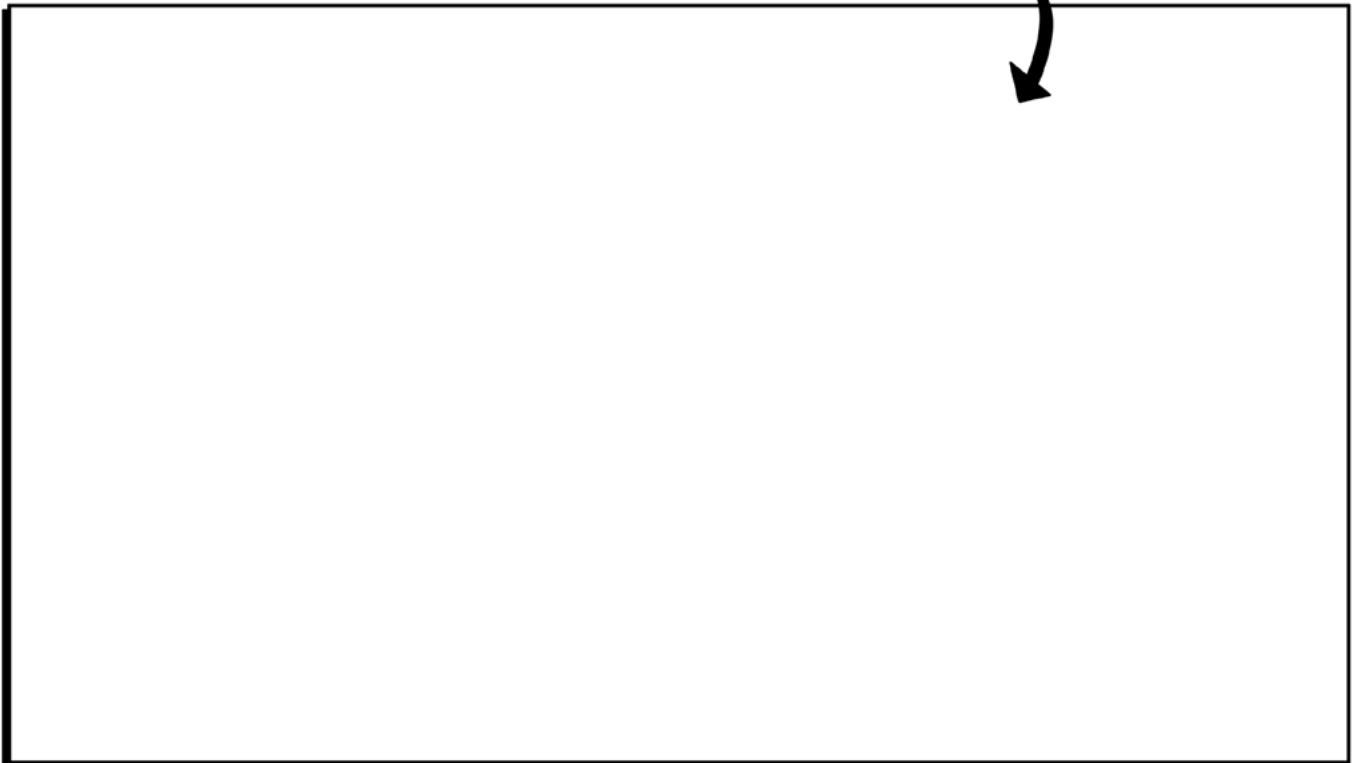

SHEPHERD

Use a pencil,
Erase LINE after step 4

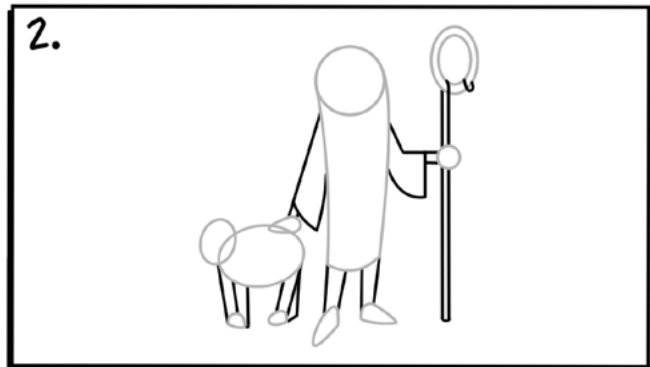
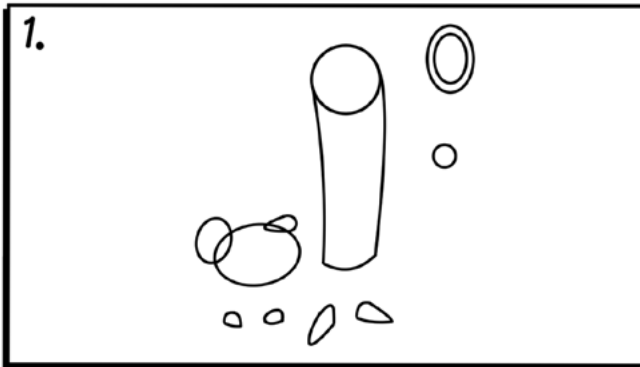

Jesus is the good shepherd - John 10:11

Now it's Your turn!

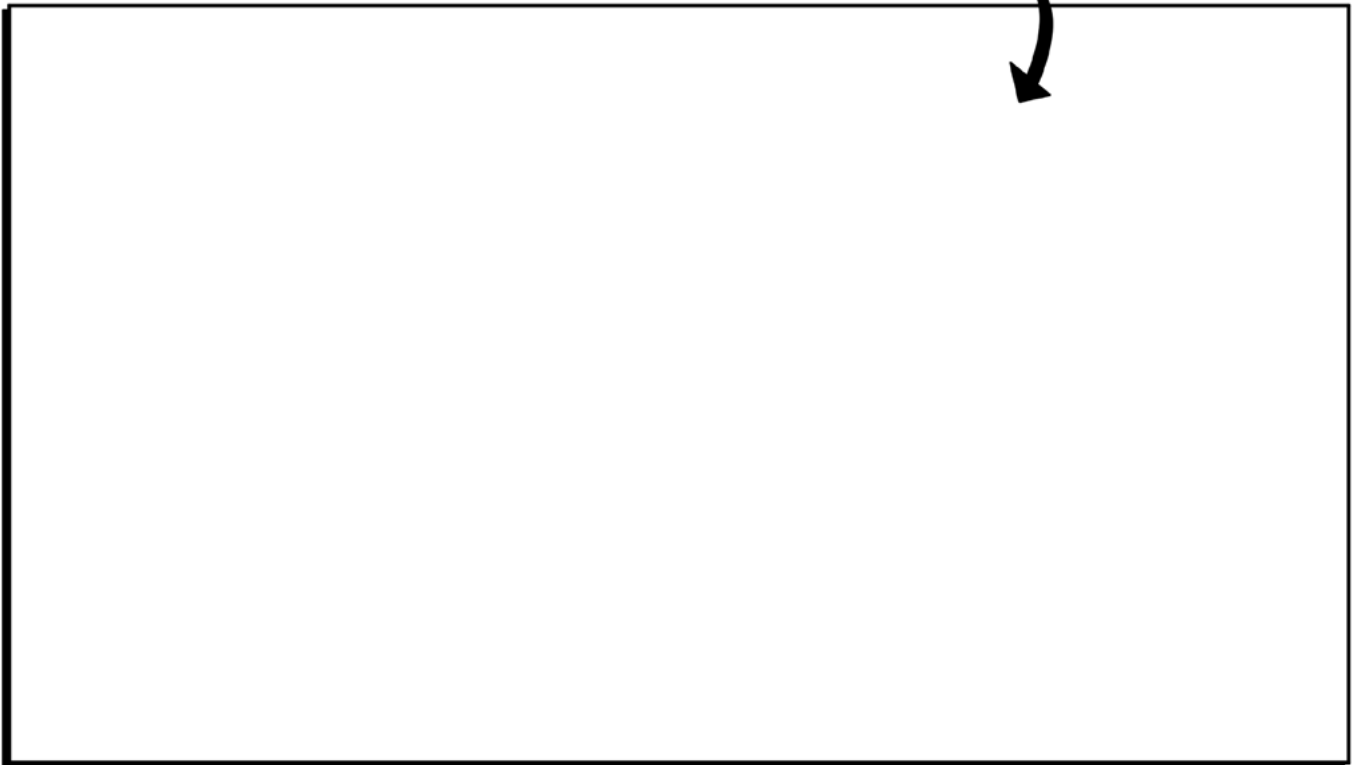

Learn to Draw...

SPARROW

Use a pencil,
Erase LINE after step 4

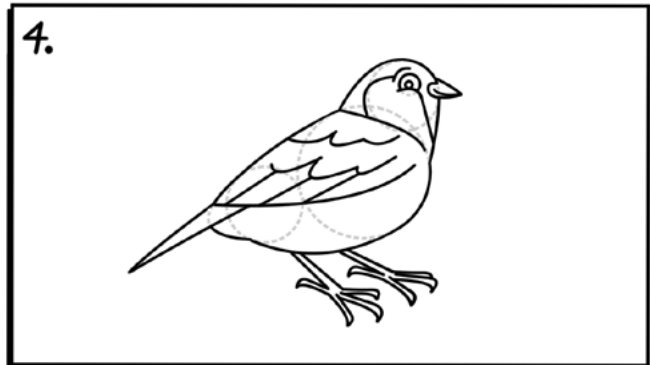
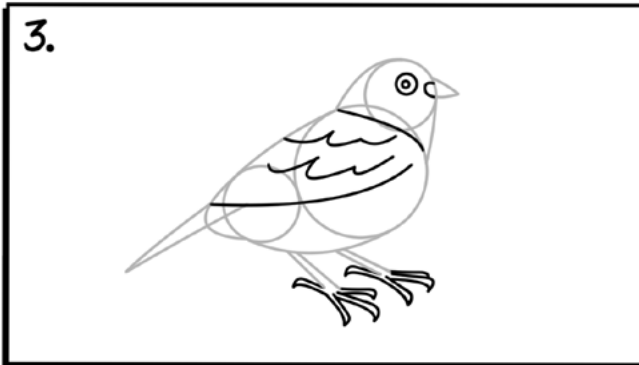
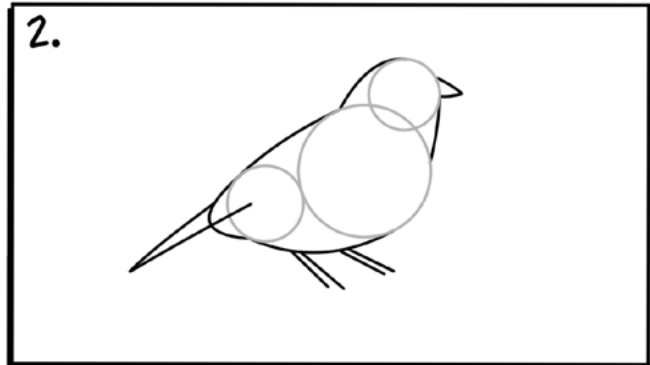
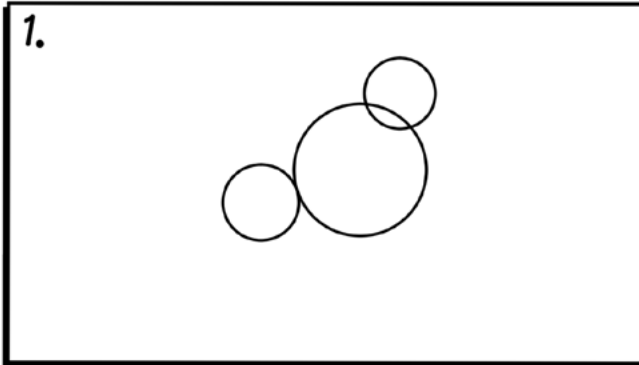

You are worth more than many sparrows - Matthew 10:31

Now it's Your turn!

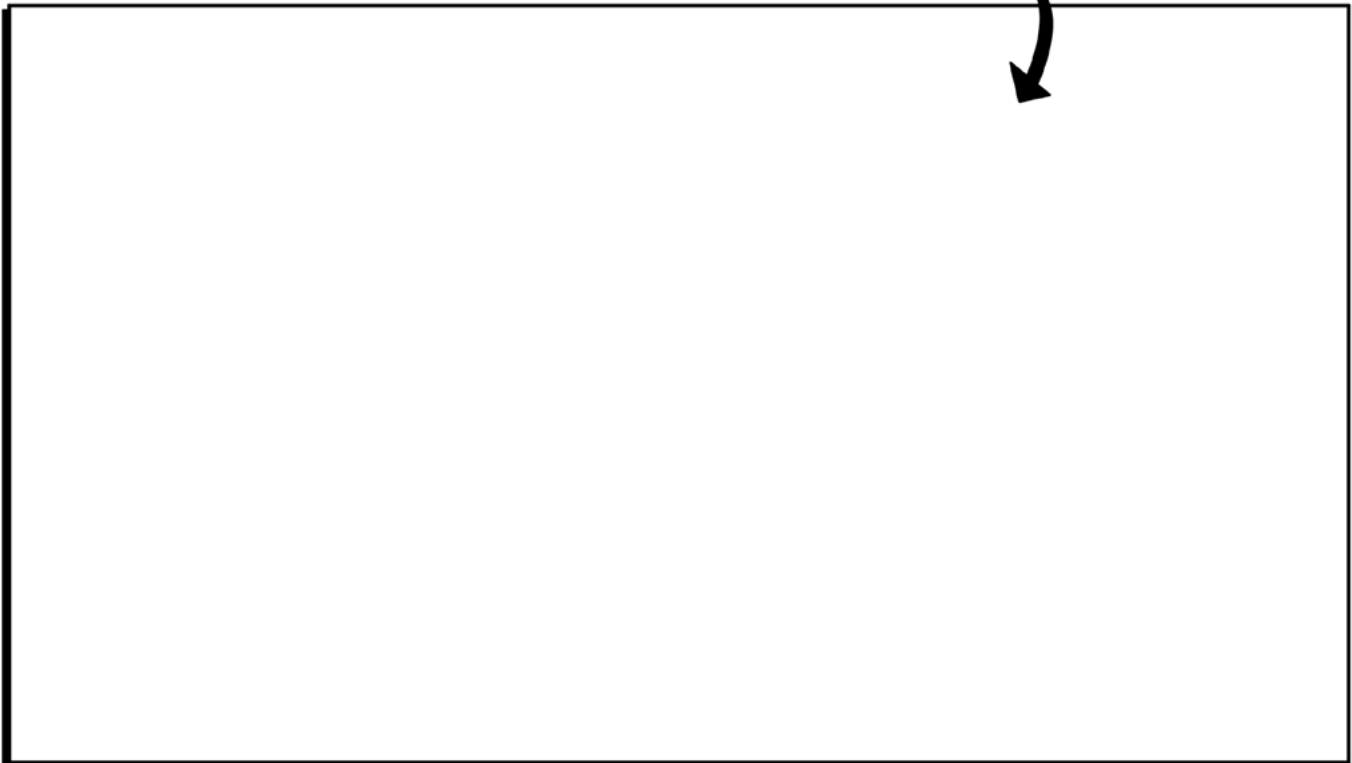

Learn to Draw...

FLOWER

Use a pencil,
Erase LINE after step 4

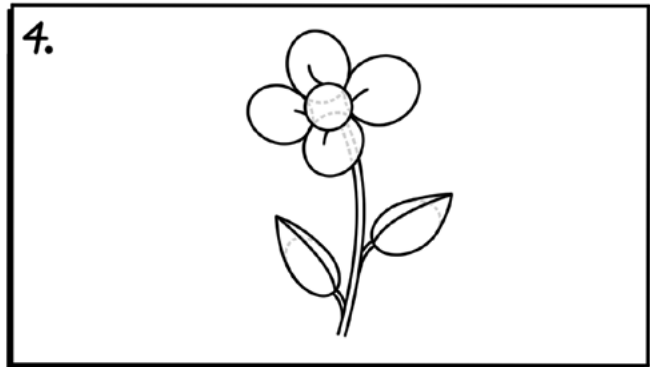
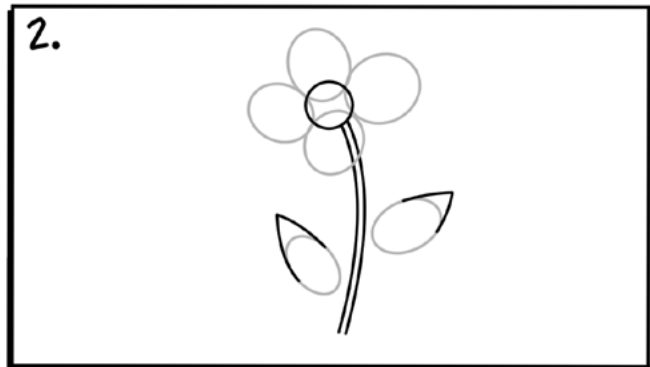
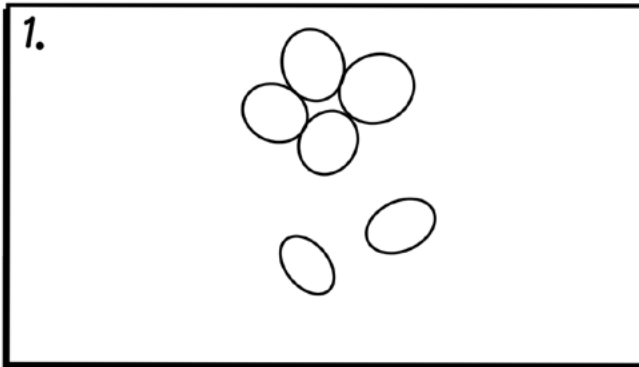

The flower fades, but God's word stands forever - Isaiah 40:8

Now it's Your turn!

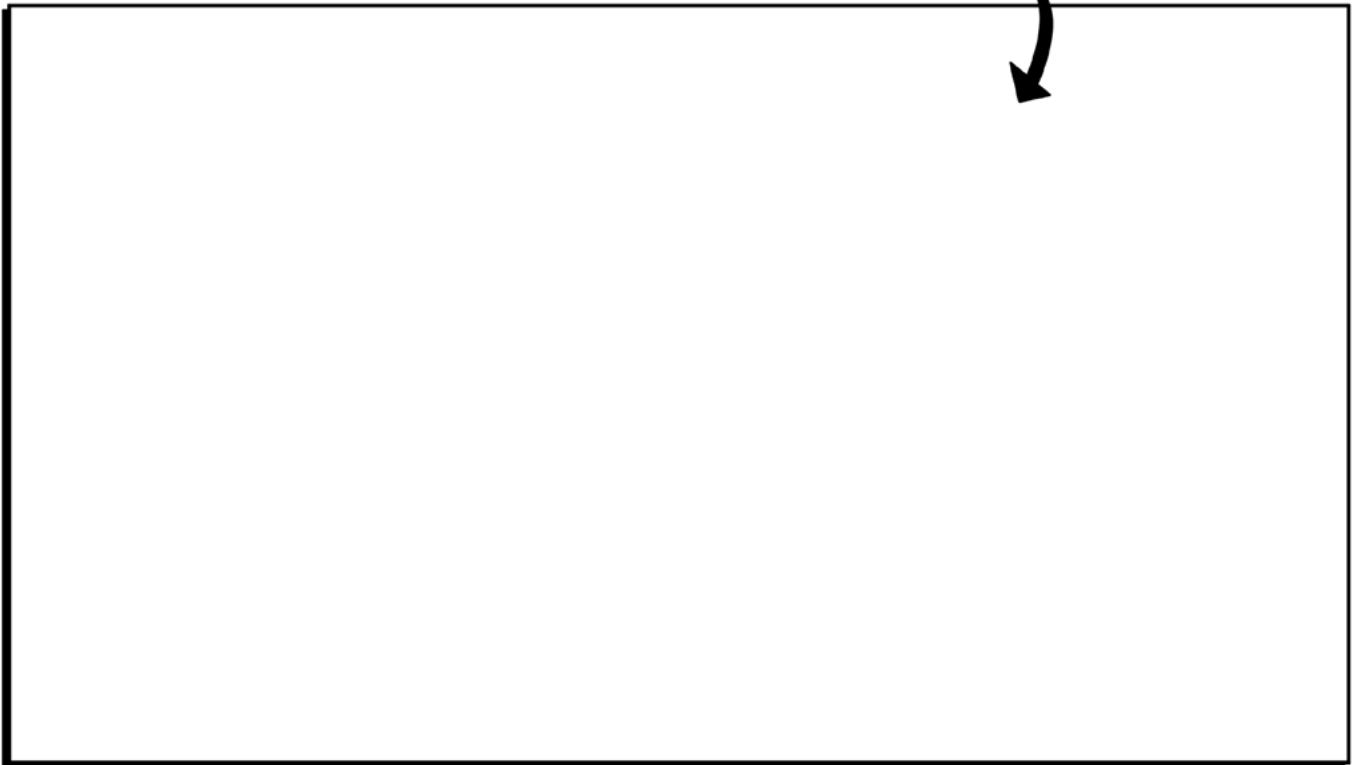

DONKEY

Use a pencil,
Erase LINE after step 4

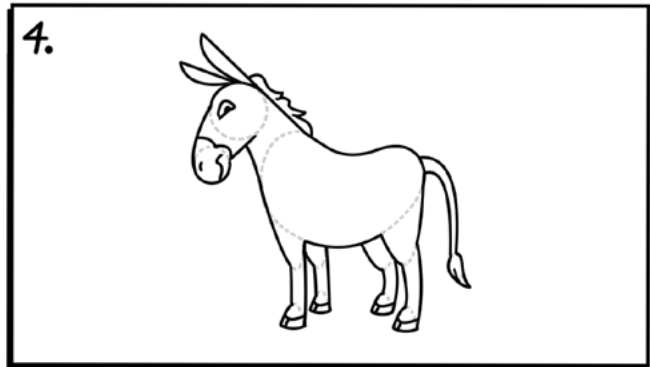
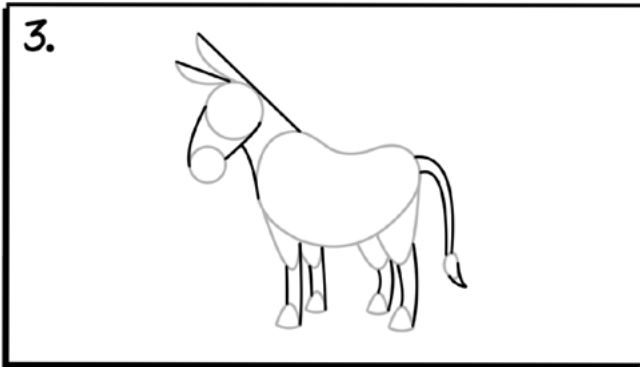
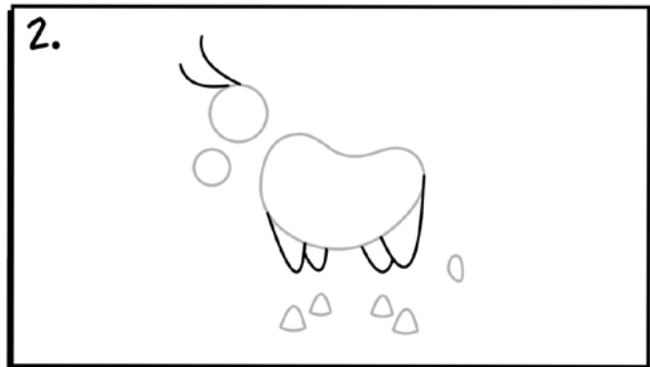
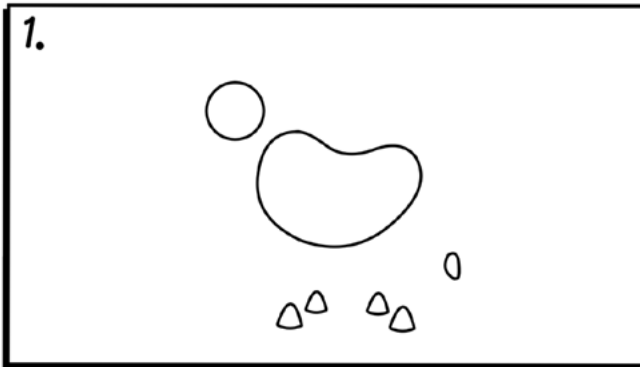

Jesus rode on a donkey on Palm Sunday

Now it's Your turn!

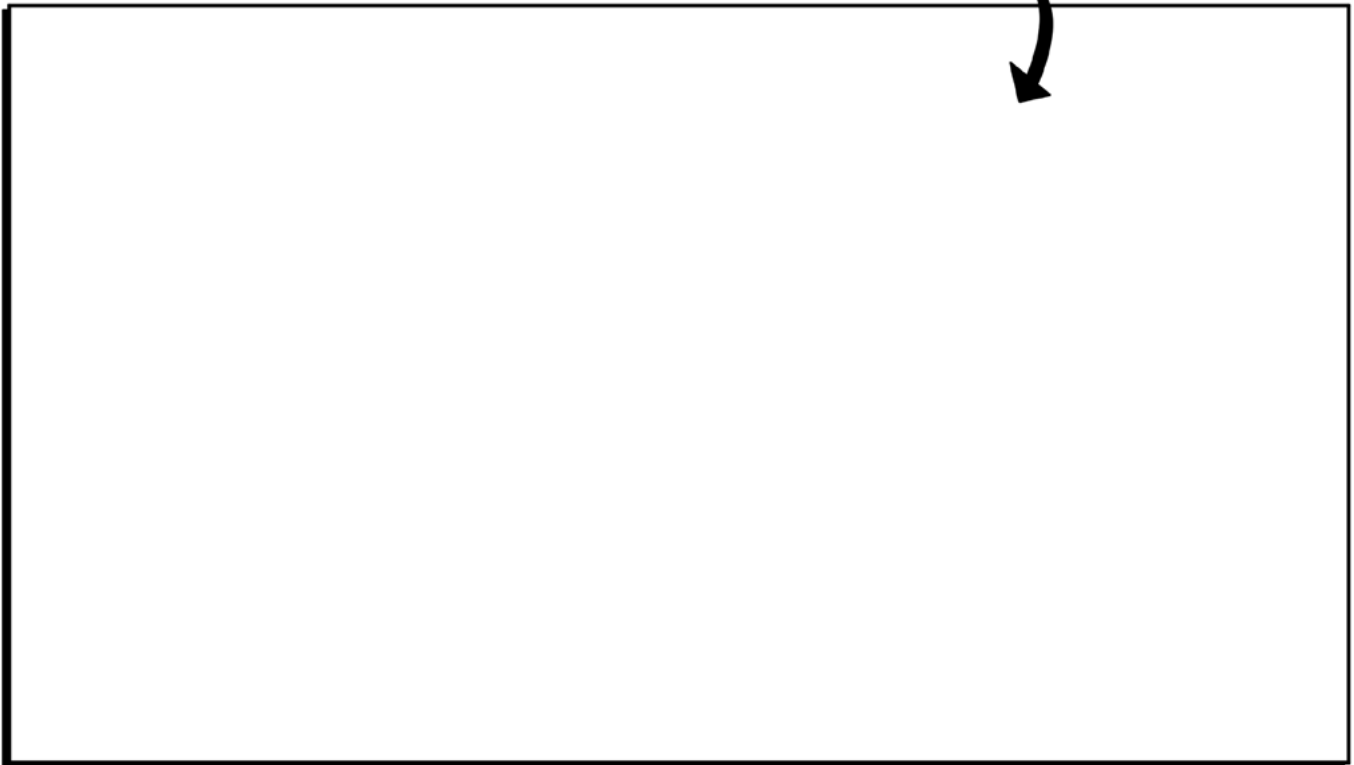

Learn to Draw...

LION

Use a pencil,
Erase LINE after step 4

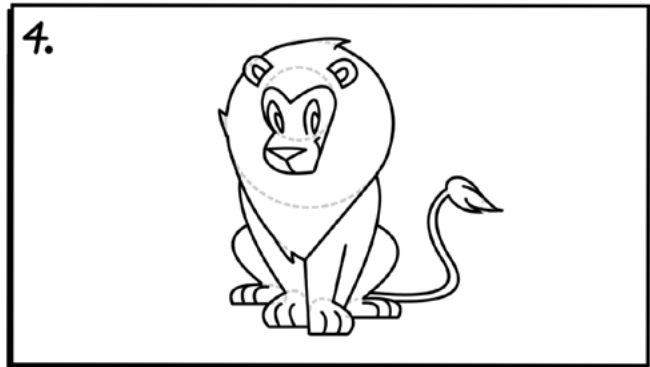
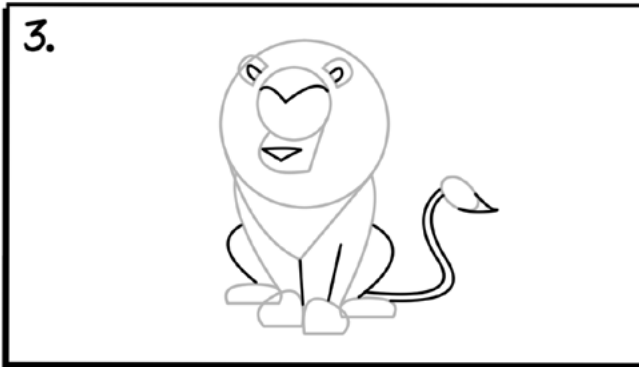
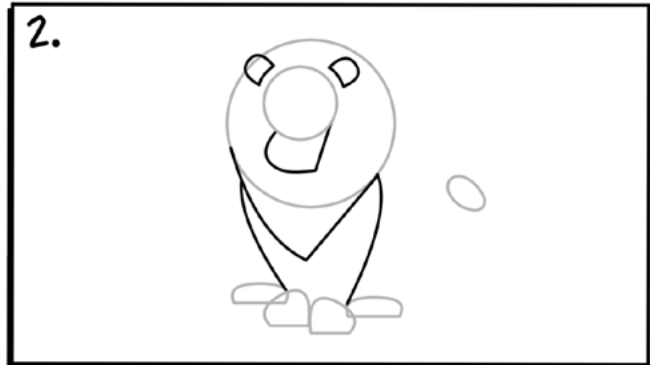
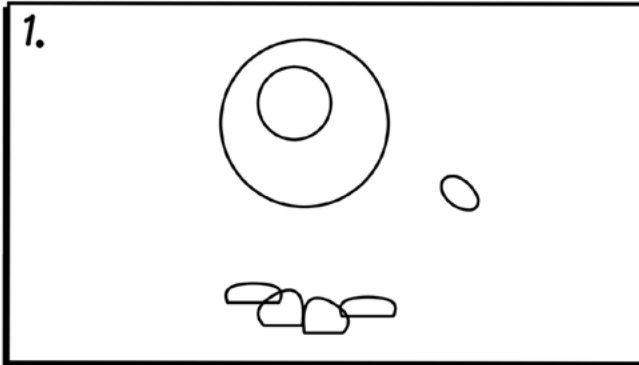

Jesus is called the Lion of Judah - Revelation 5:5

Now it's Your turn!

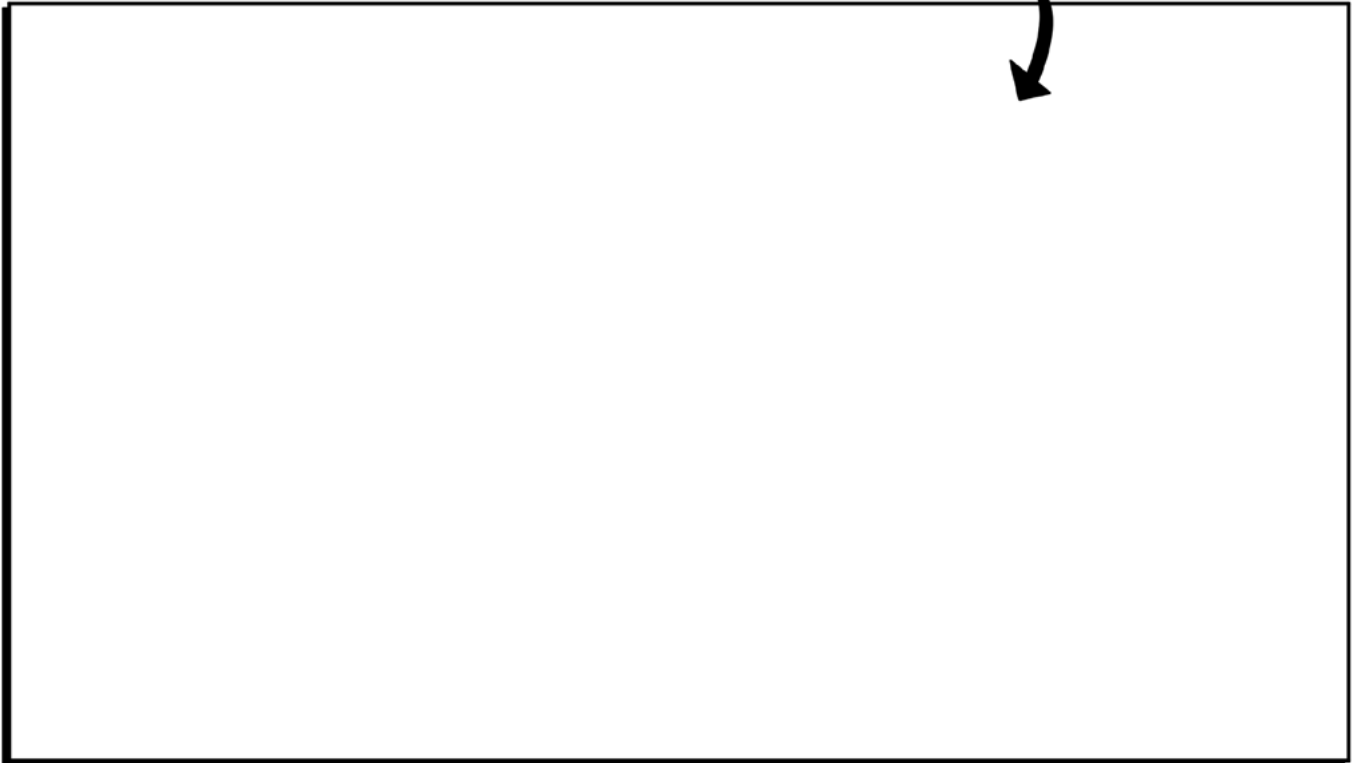

Learn to Draw...

LAMB

Use a pencil,
Erase LINE after step 4

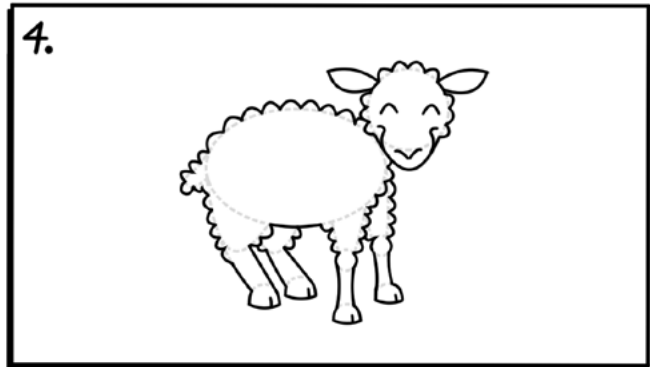
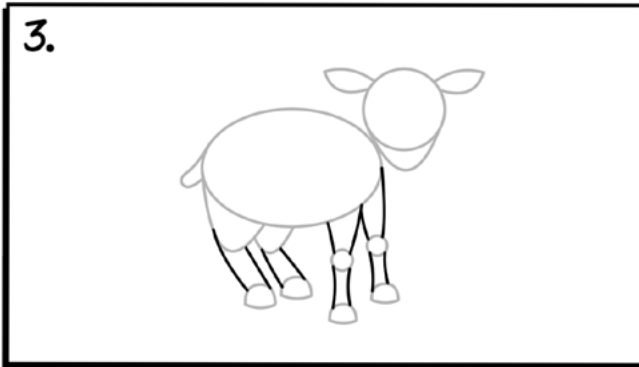
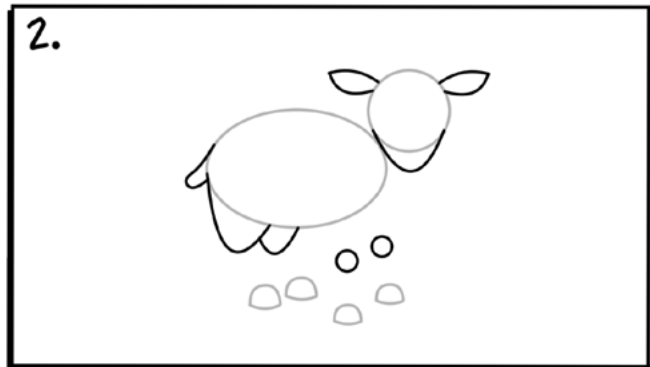
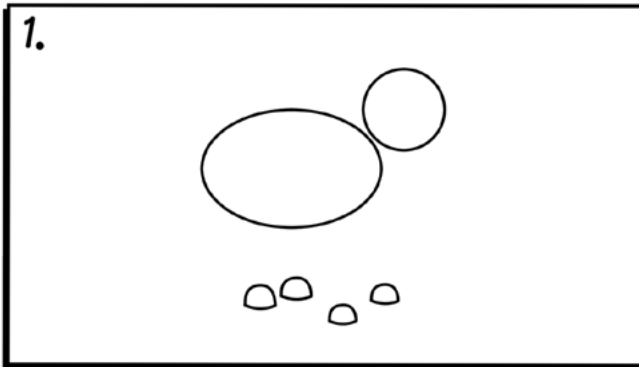

Jesus is called the Lamb of God - John 1:29

Now it's Your turn!

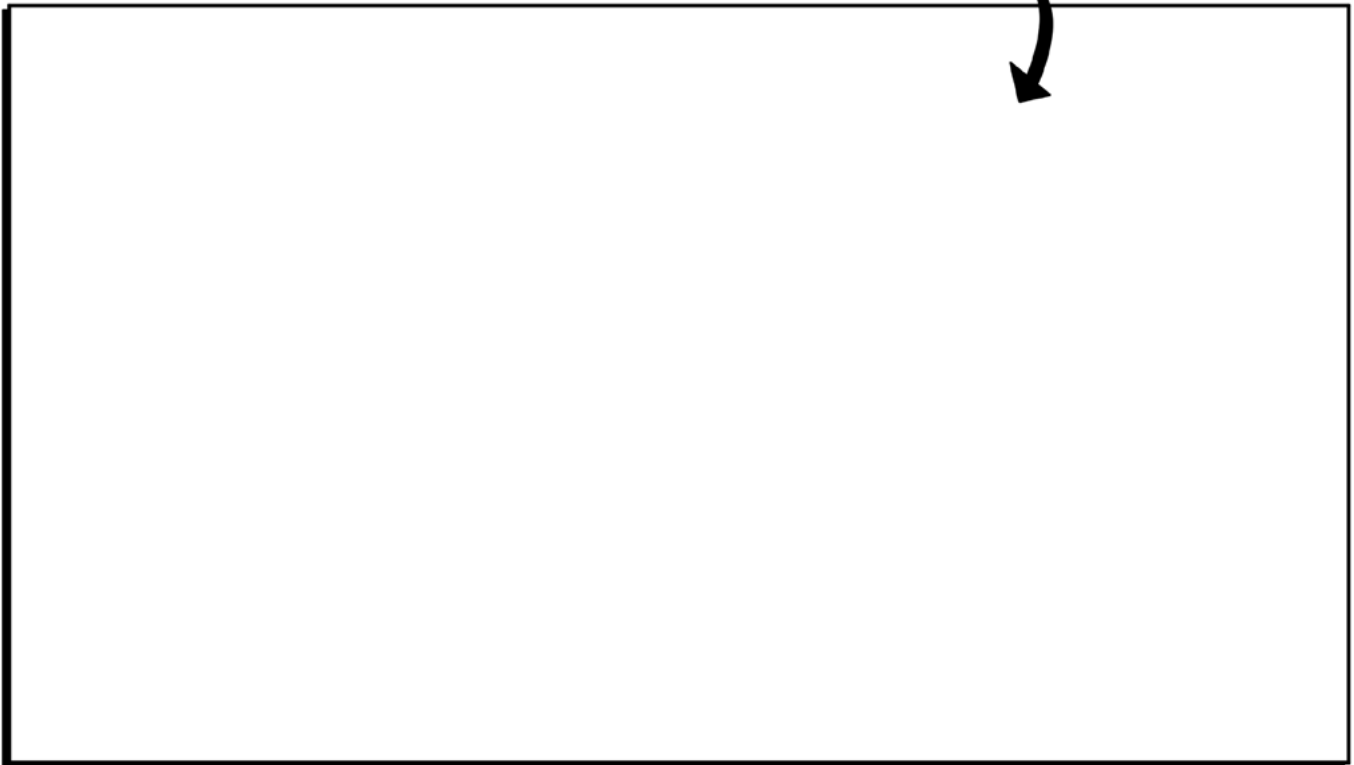

Learn to Draw...

FISH

Use a pencil,
Erase LINE after step 4

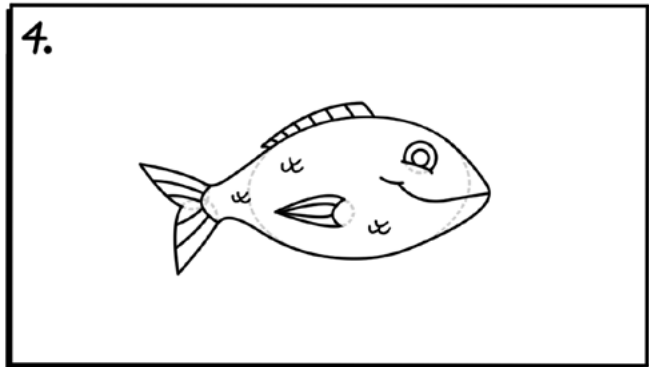
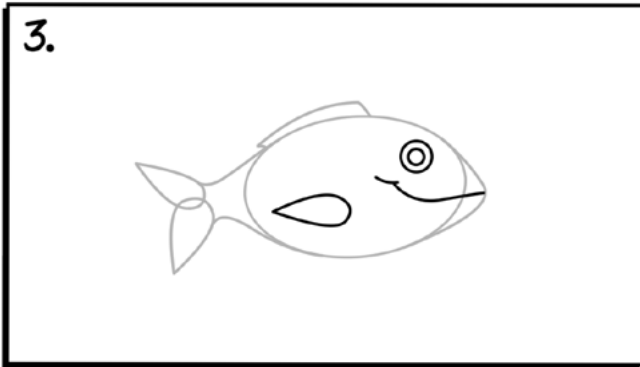
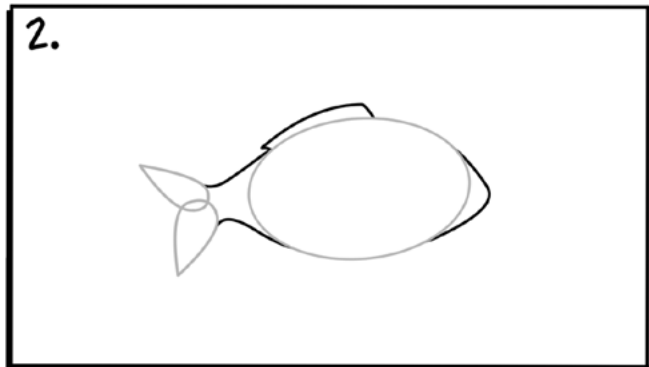
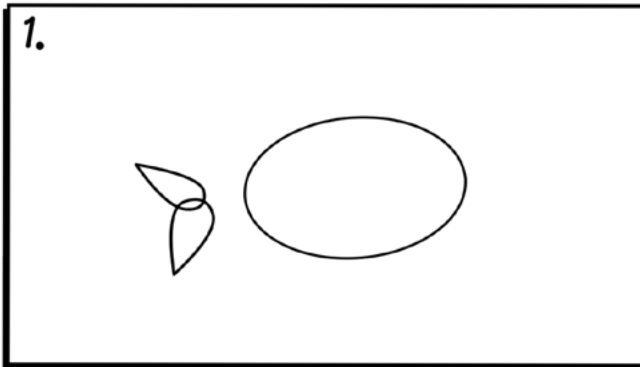

Jesus said "Follow me, and I will make you fishers of men." - Matthew 5:14

Now it's Your turn!

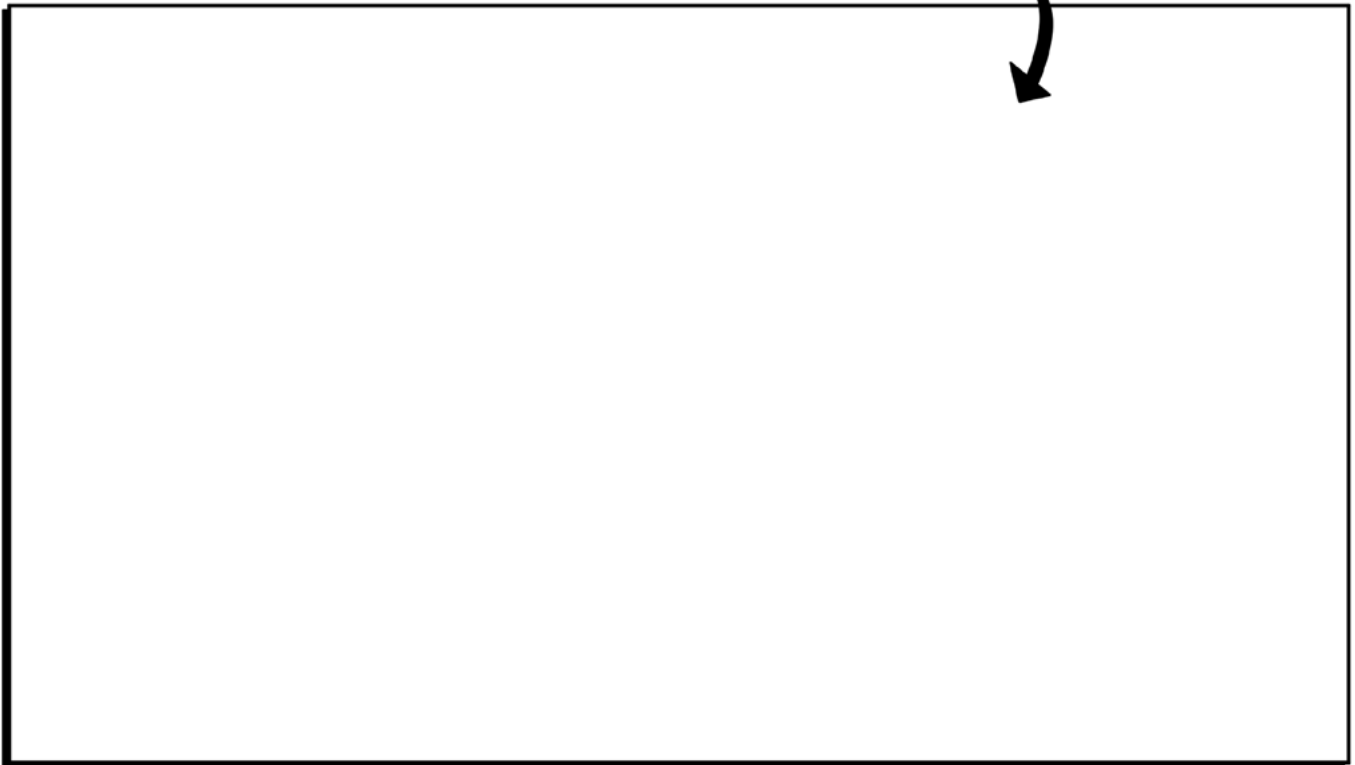

Learn to Draw...

LANTERN

Use a pencil,
Erase LINE after step 4

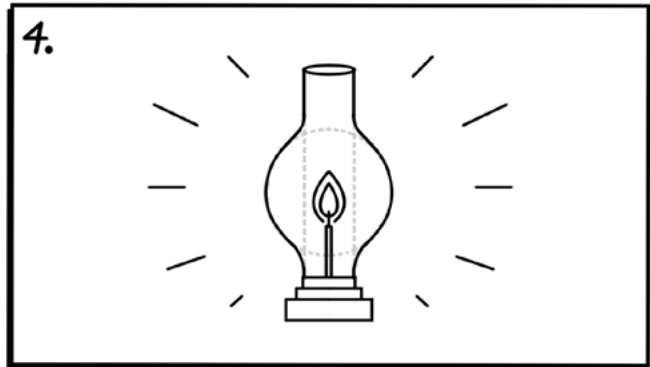
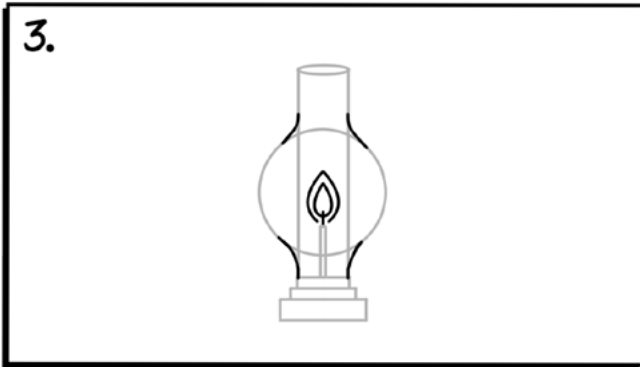
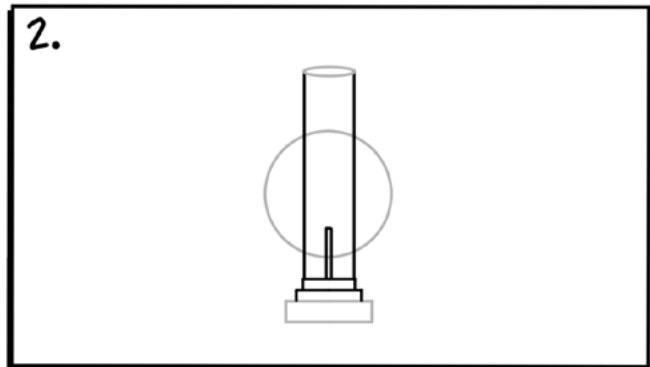
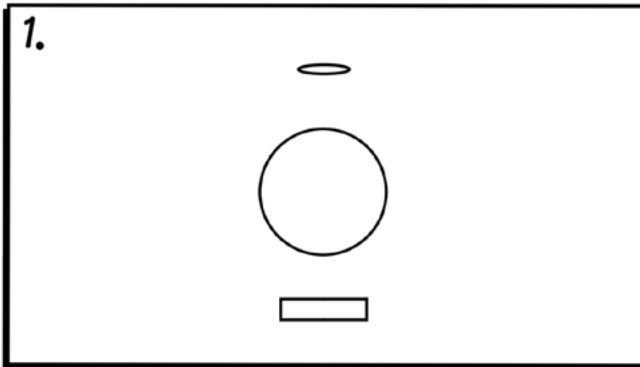

Jesus said "You are the light of the world." - Matthew 5:14

Now it's Your turn!

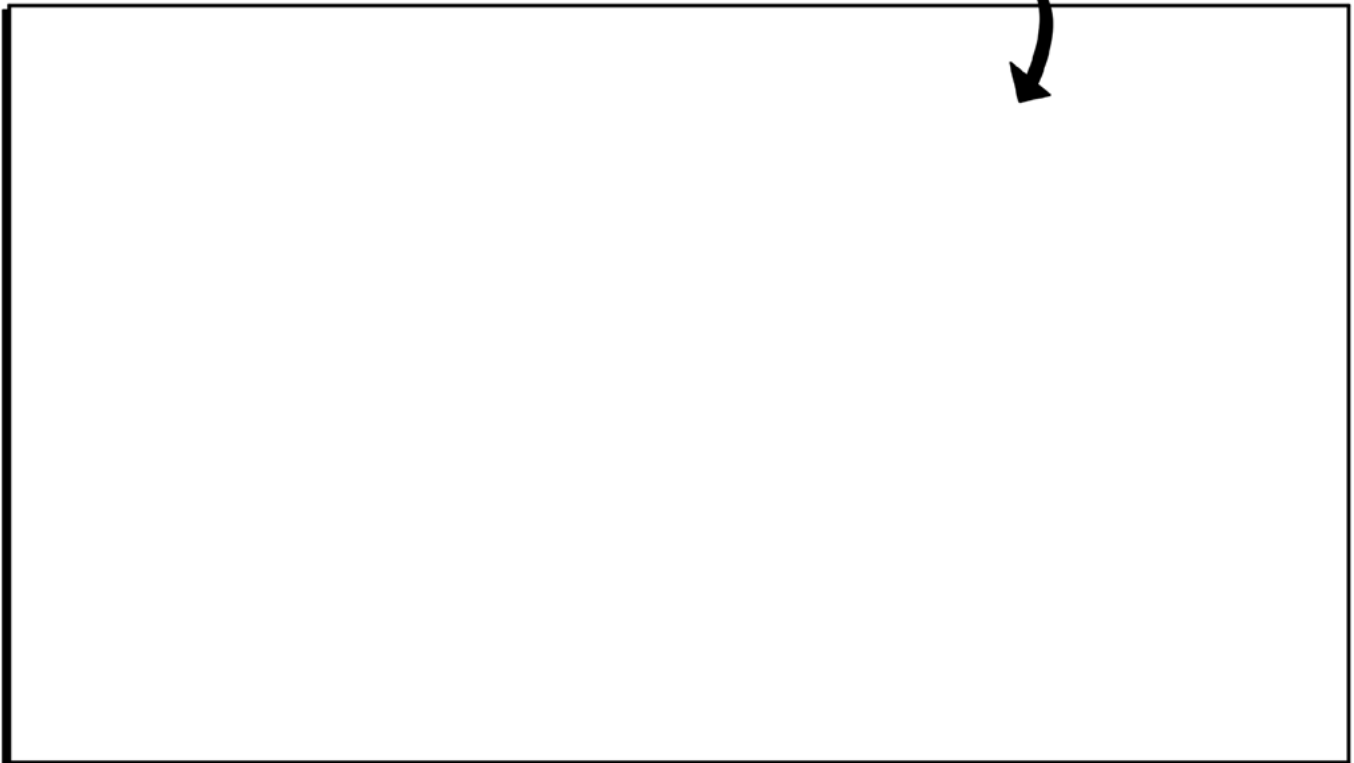

Learn to Draw...

TREE

Use a pencil,
Erase LINE after step 4

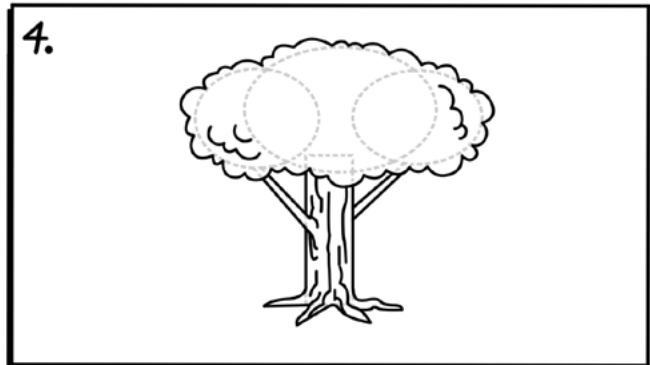
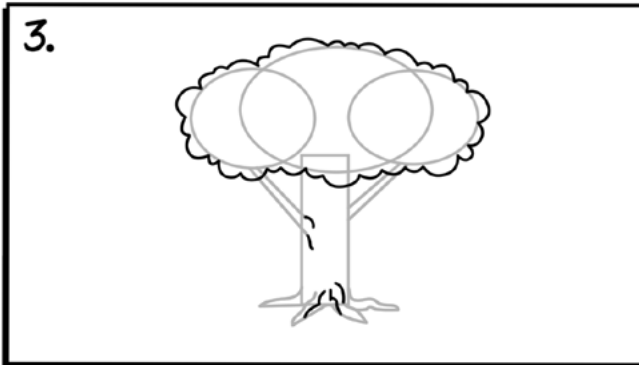
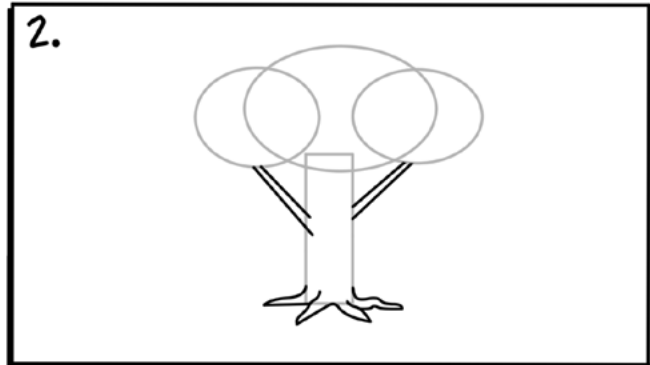
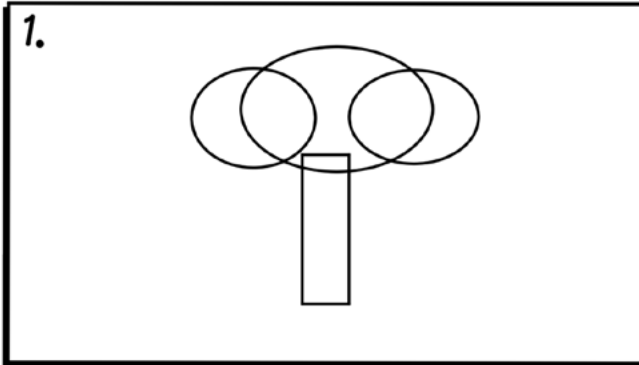

In the bible, strong Christians are compared to trees

Now it's Your turn!

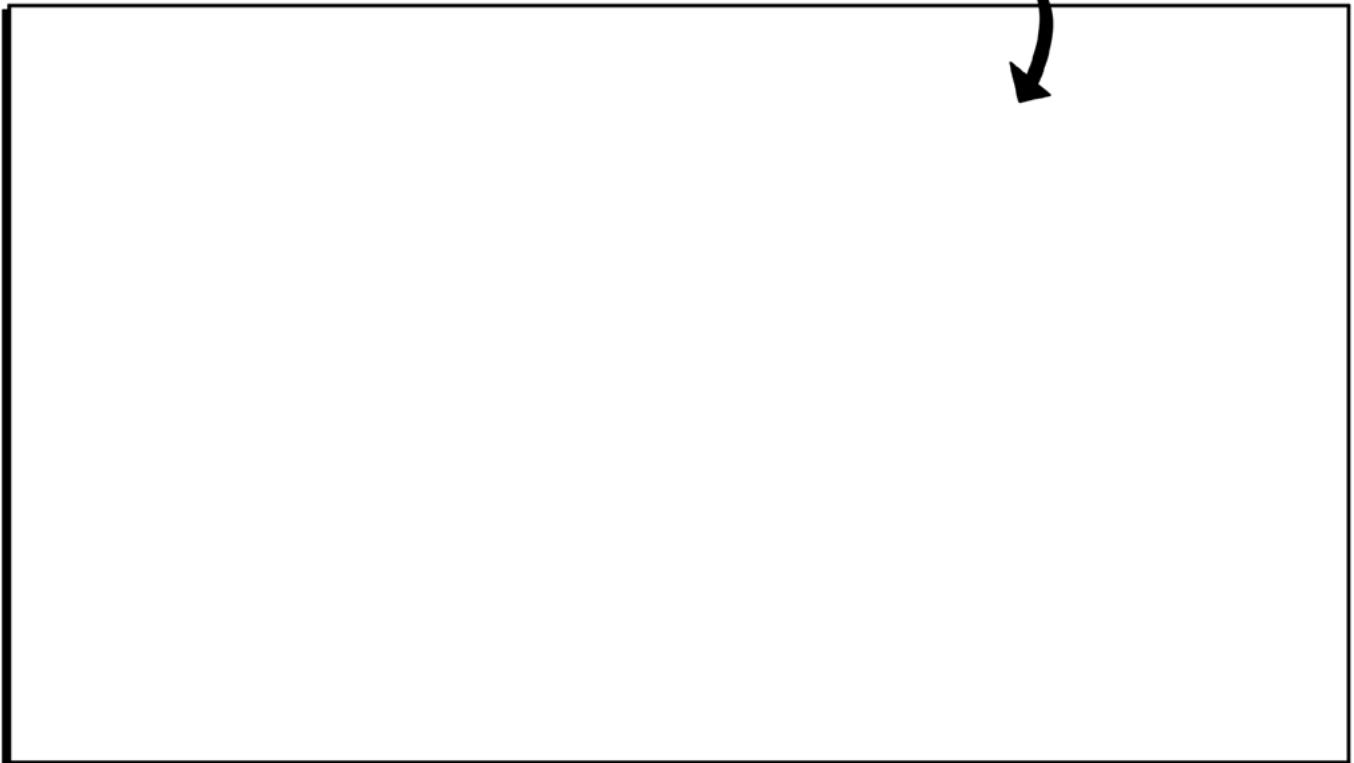

Learn to Draw...

SNAKE

Use a pencil,
Erase LINE after step 4

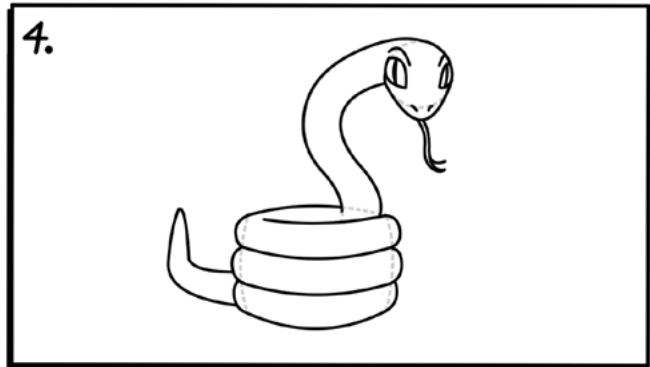
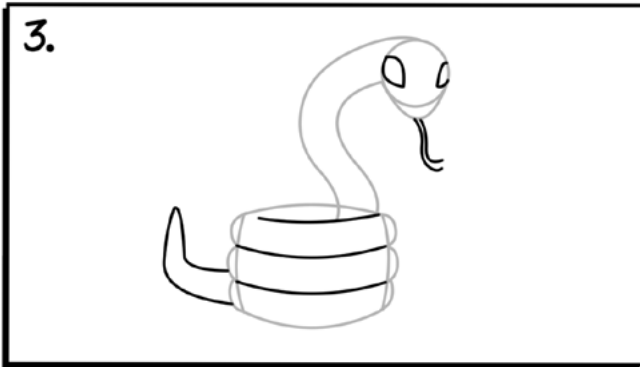
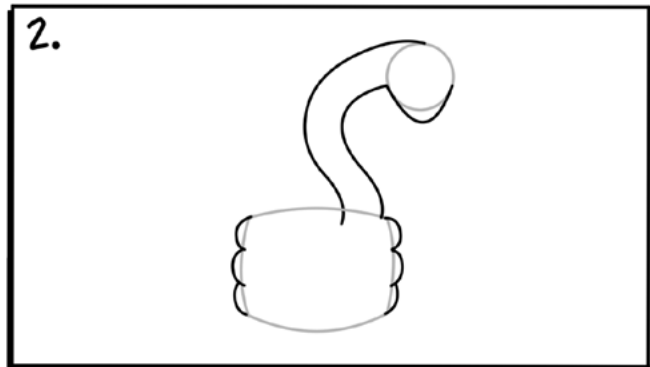
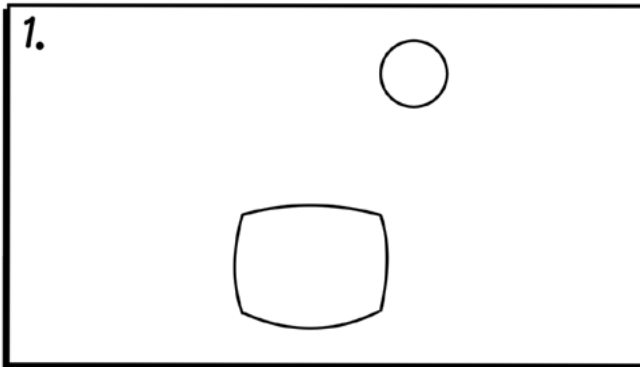

In the bible, the snake is an animal who tricks people

Now it's Your turn!

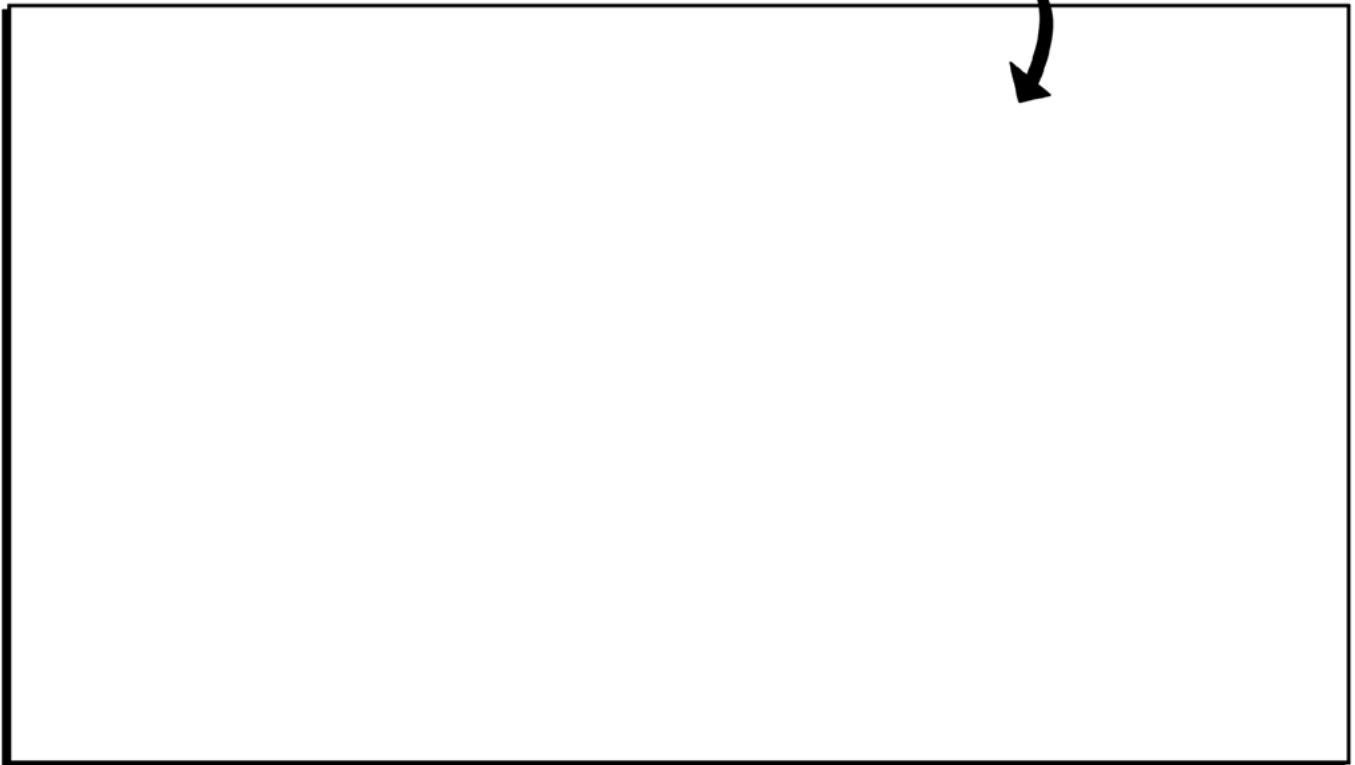

WHALE

Use a pencil,
Erase LINE after step 4

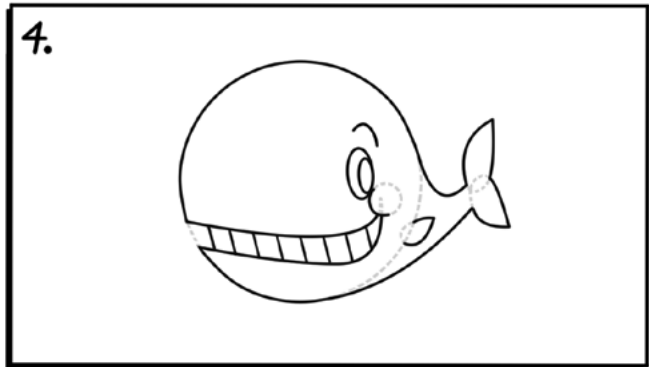
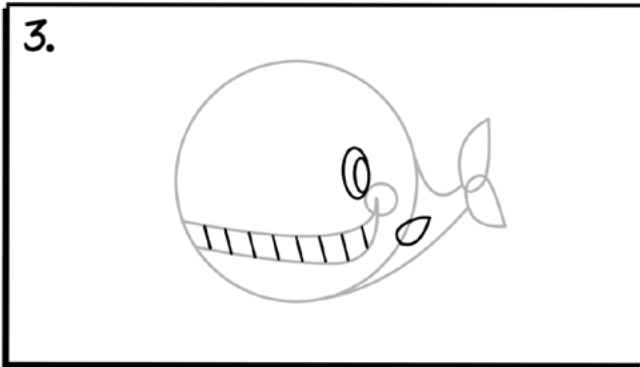
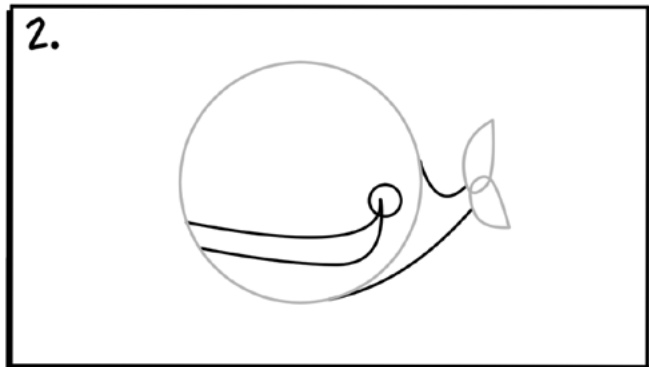
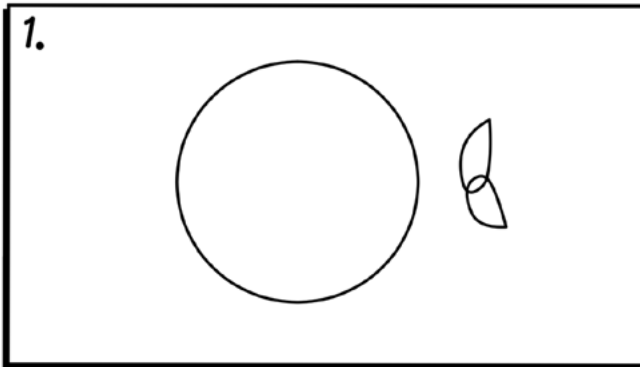

Jonah got swallowed by a whale

Now it's Your turn!

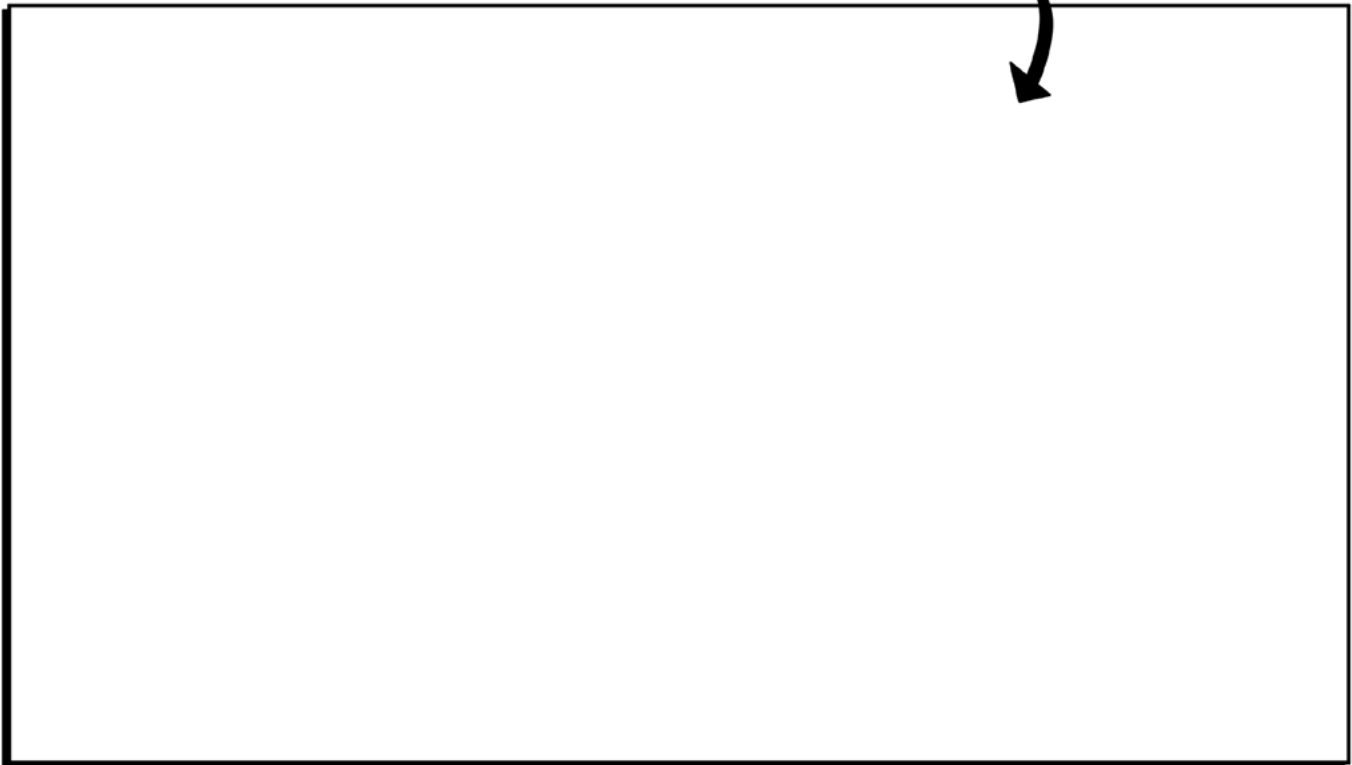

Learn to Draw...

BOAT

Use a pencil,
Erase LINE after step 4

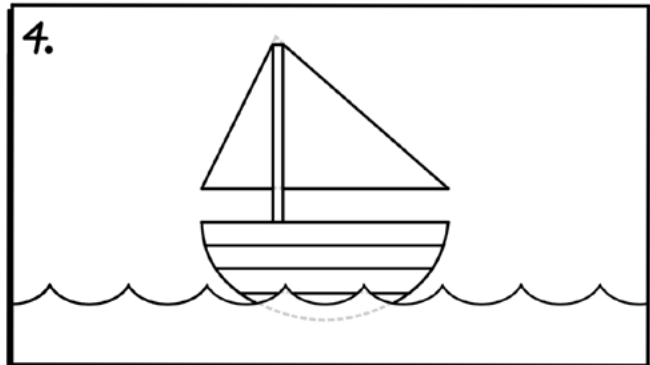
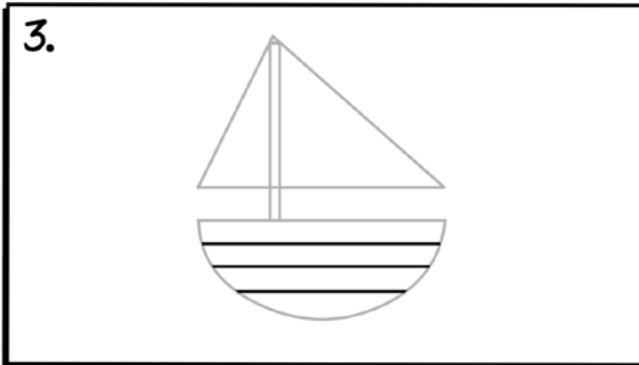
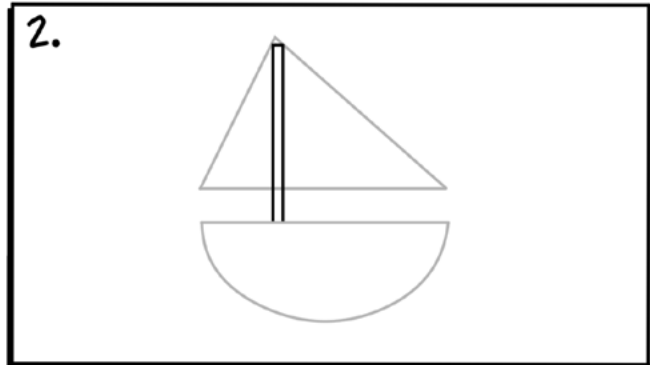
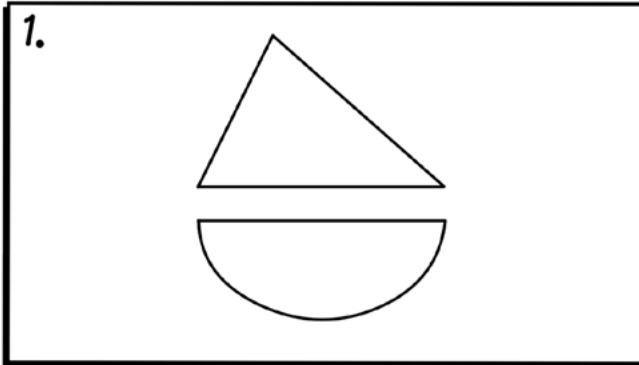

While in a boat, Jesus calmed a loud and scary storm

Now it's Your turn!

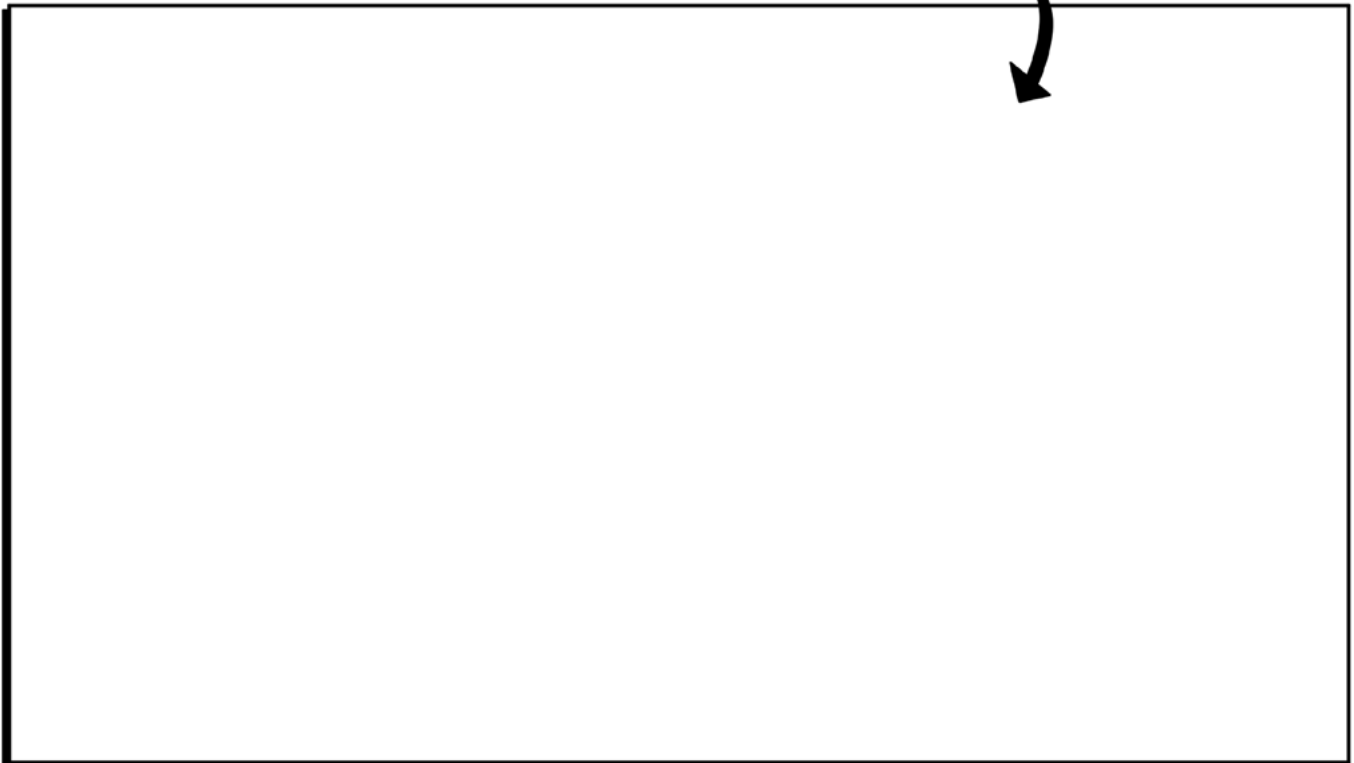

CUT 'N PASTE PUZZLES



Cut-Paste-Color!

Cut along the dotted lines & arrange in order below.

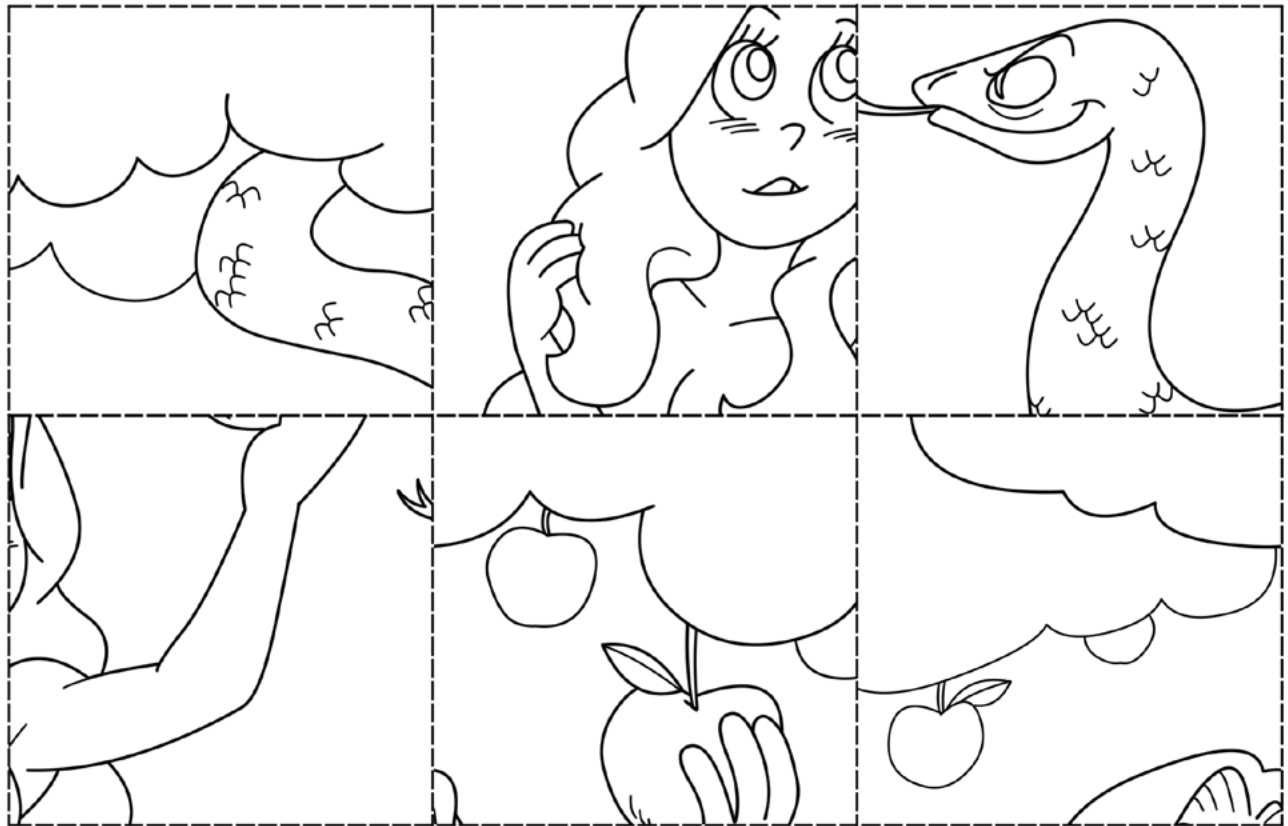

In the Garden of Eden, Eve takes the fruit.

Genesis 3



Cut-Paste-Color!

Cut along the dotted lines & arrange in order below.



Noah took the animals on the ark.

Genesis 7

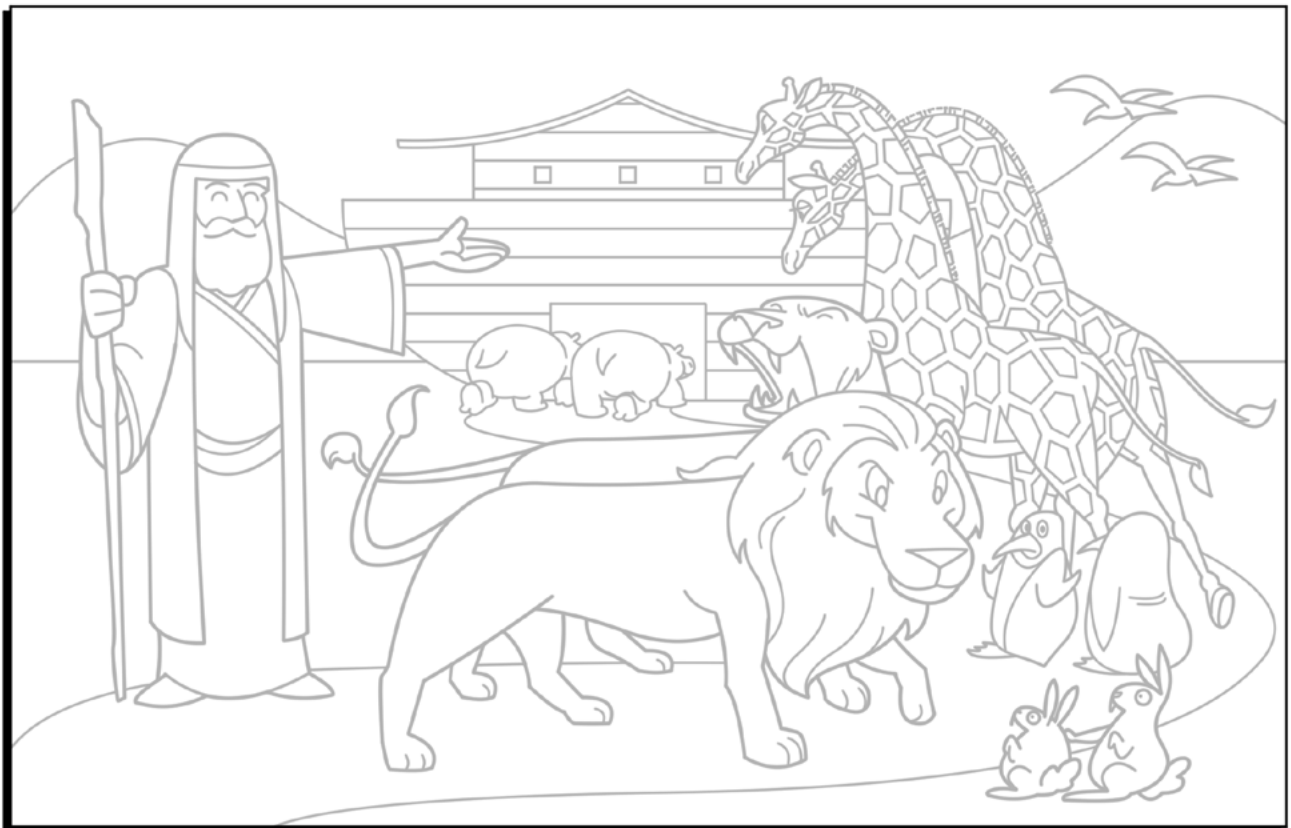

Cut-Paste-Color!

Cut along the dotted lines & arrange in order below.

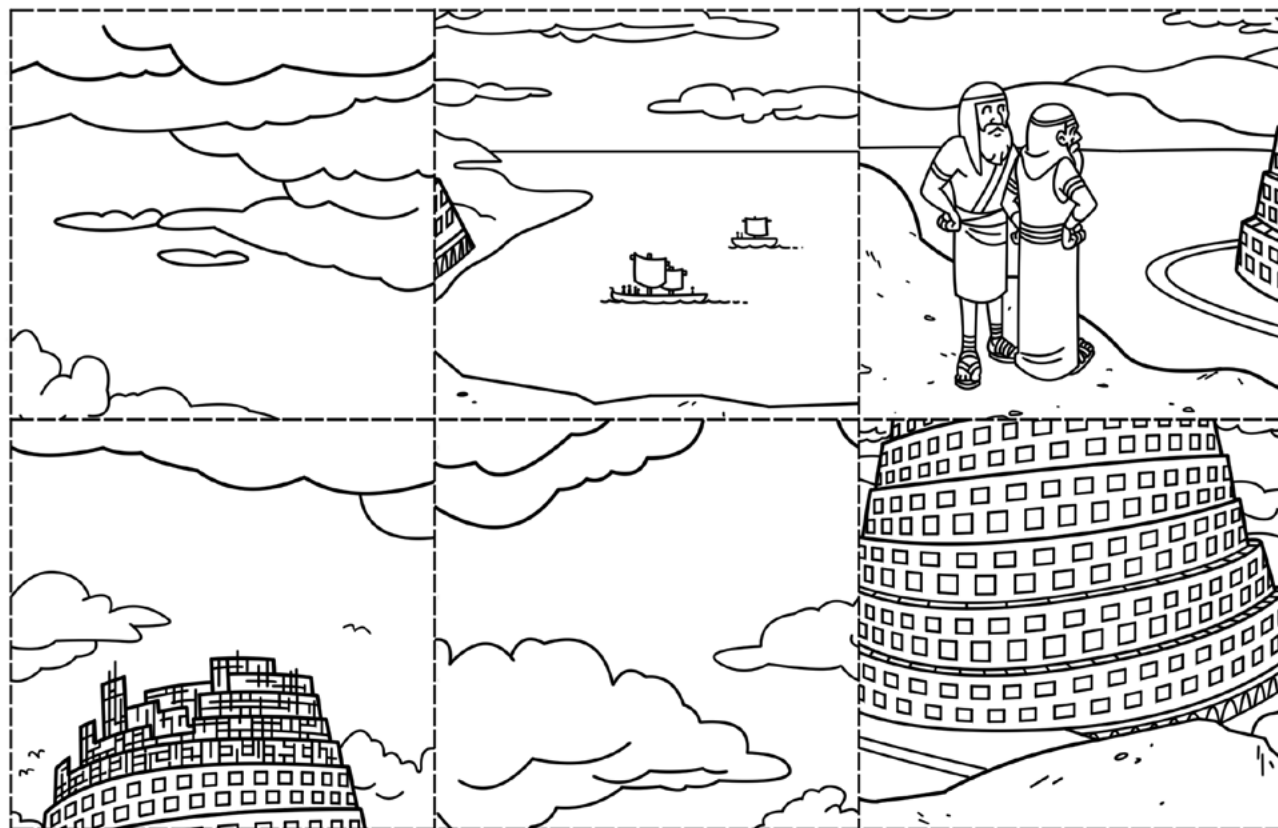

The tower of Babel was never finished.

Genesis 11

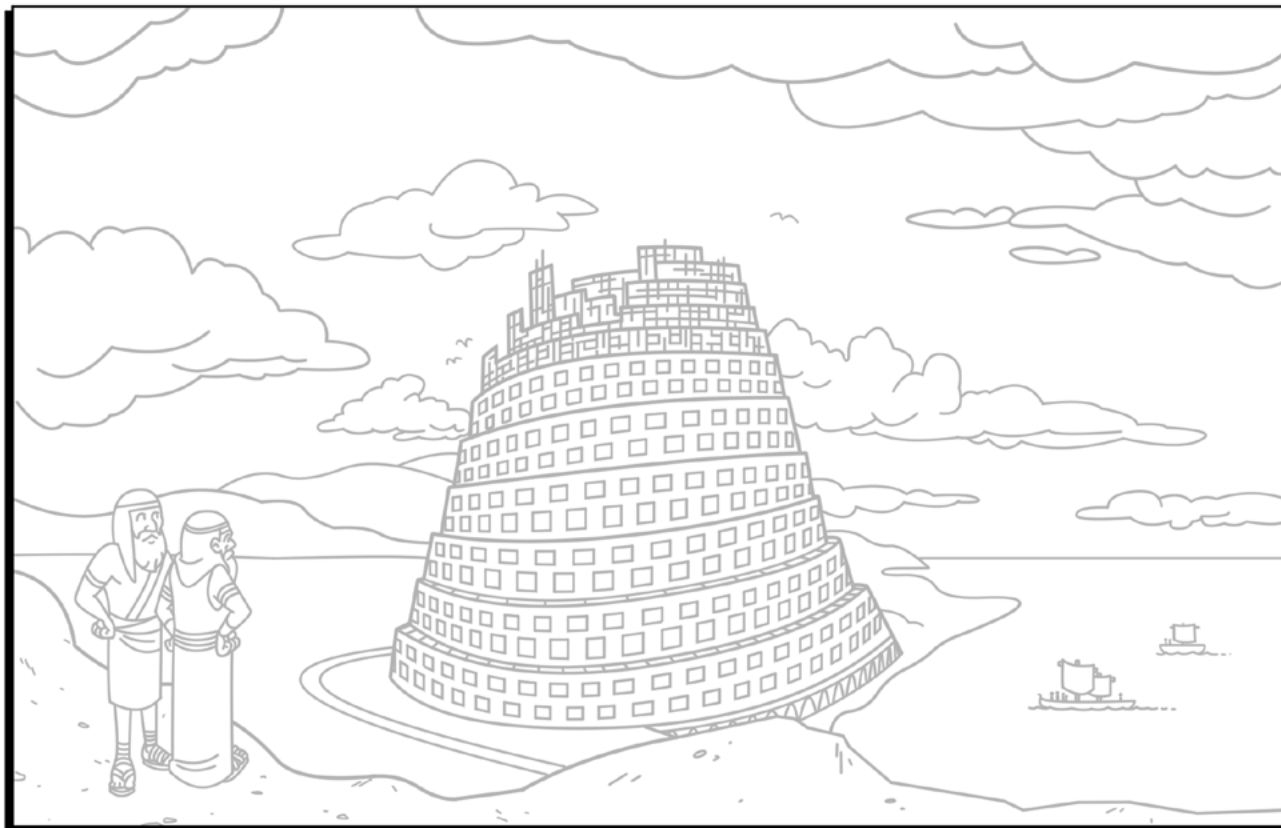

Cut-Paste-Color!

Cut along the dotted lines & arrange in order below.

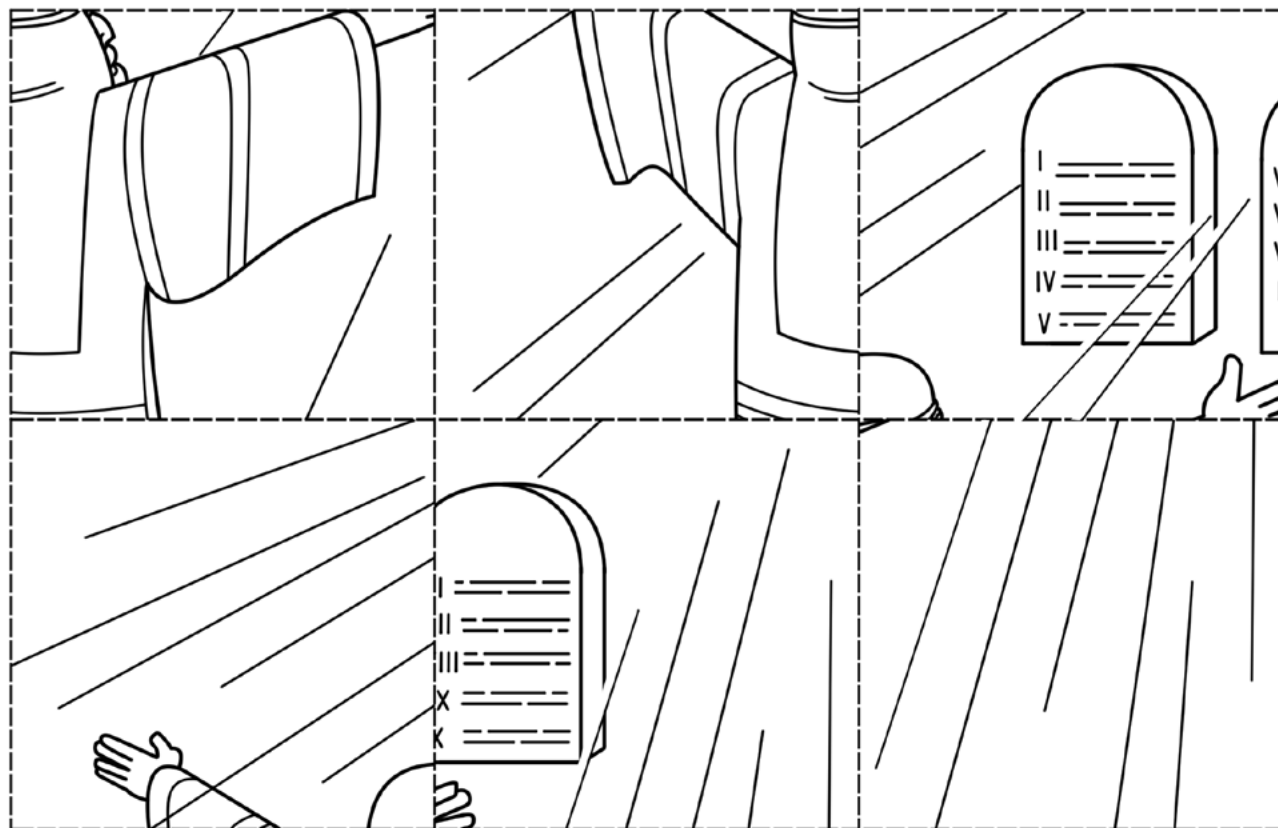

Moses gets The Ten Commandments from God. **Exodus 20**

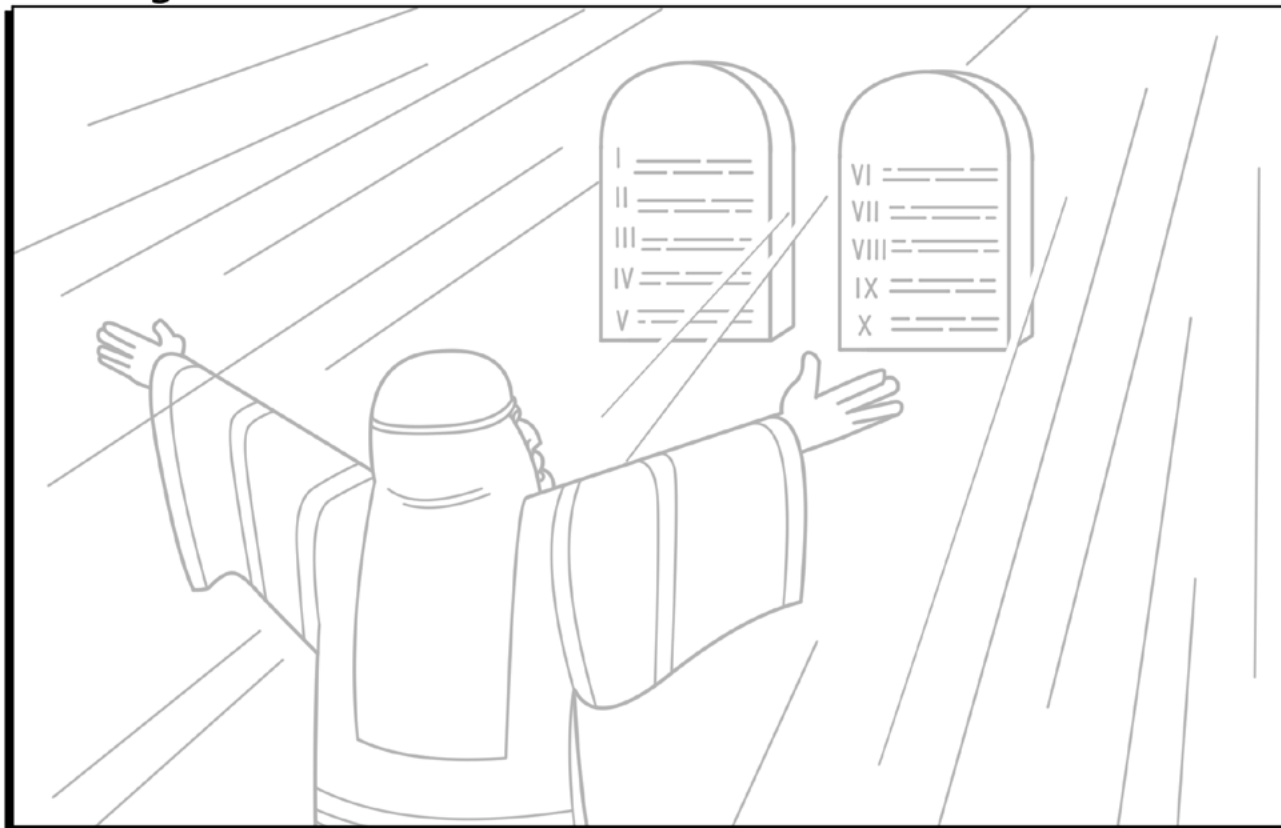

Cut-Paste-Color!

Cut along the dotted lines & arrange in order below.

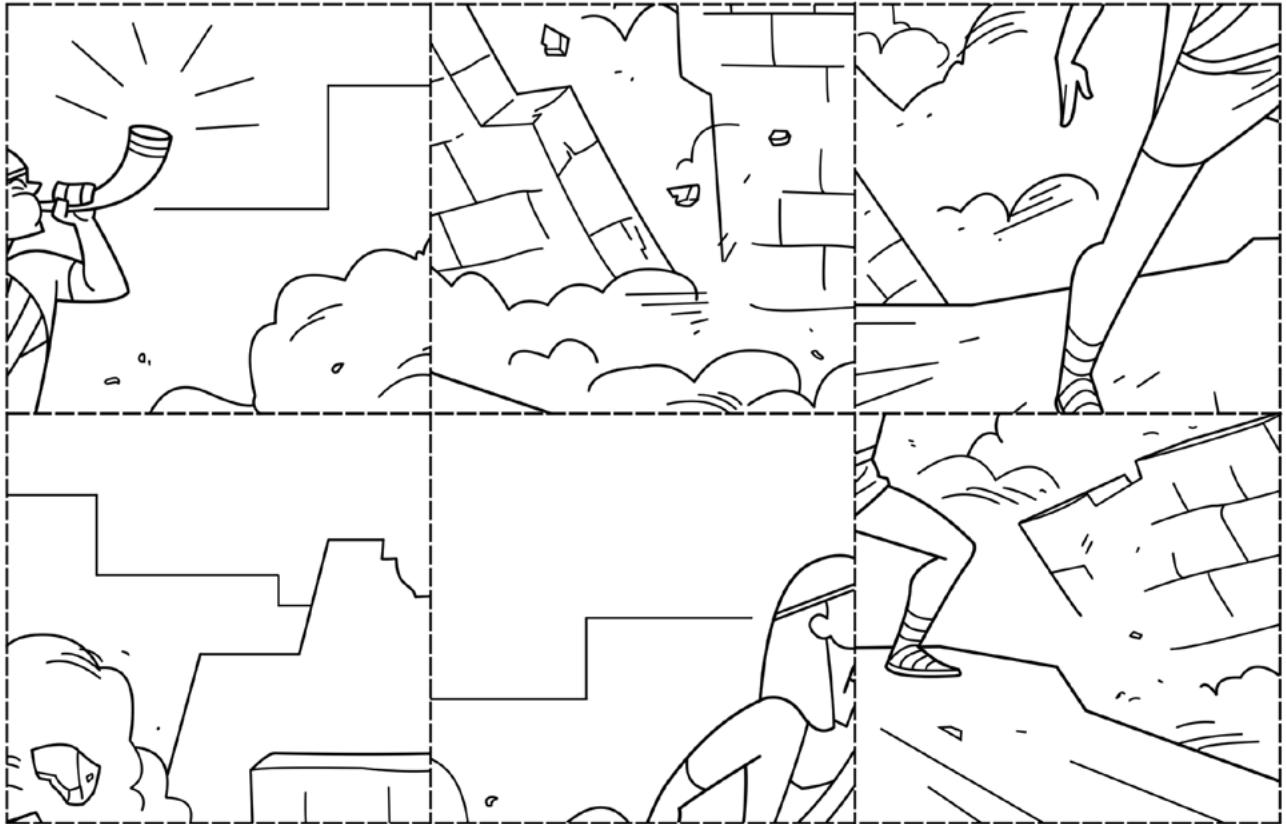

Joshua blows his horn.

Joshua 6



Cut-Paste-Color!

Cut along the dotted lines & arrange in order below.

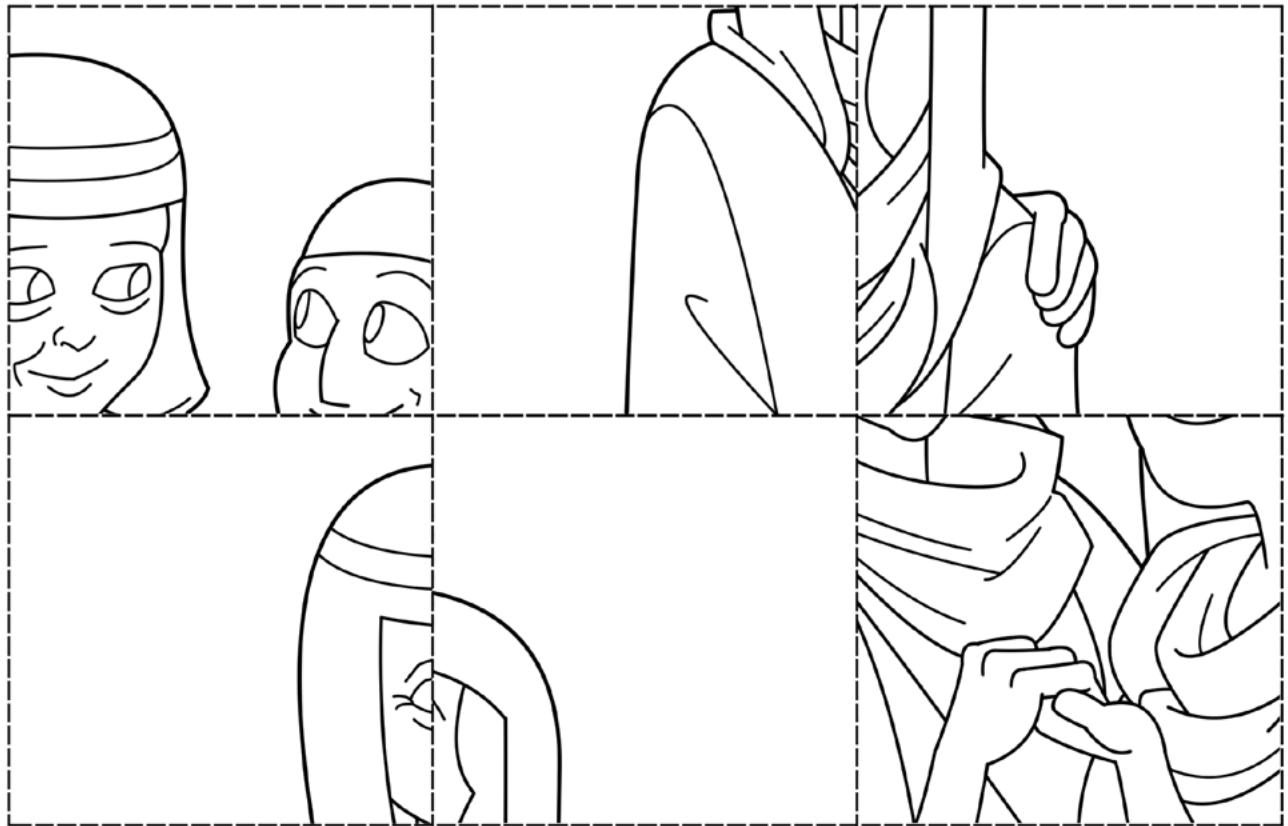

Ruth stays with Naomi.

Ruth 1



Cut-Paste-Color!

Cut along the dotted lines & arrange in order below.

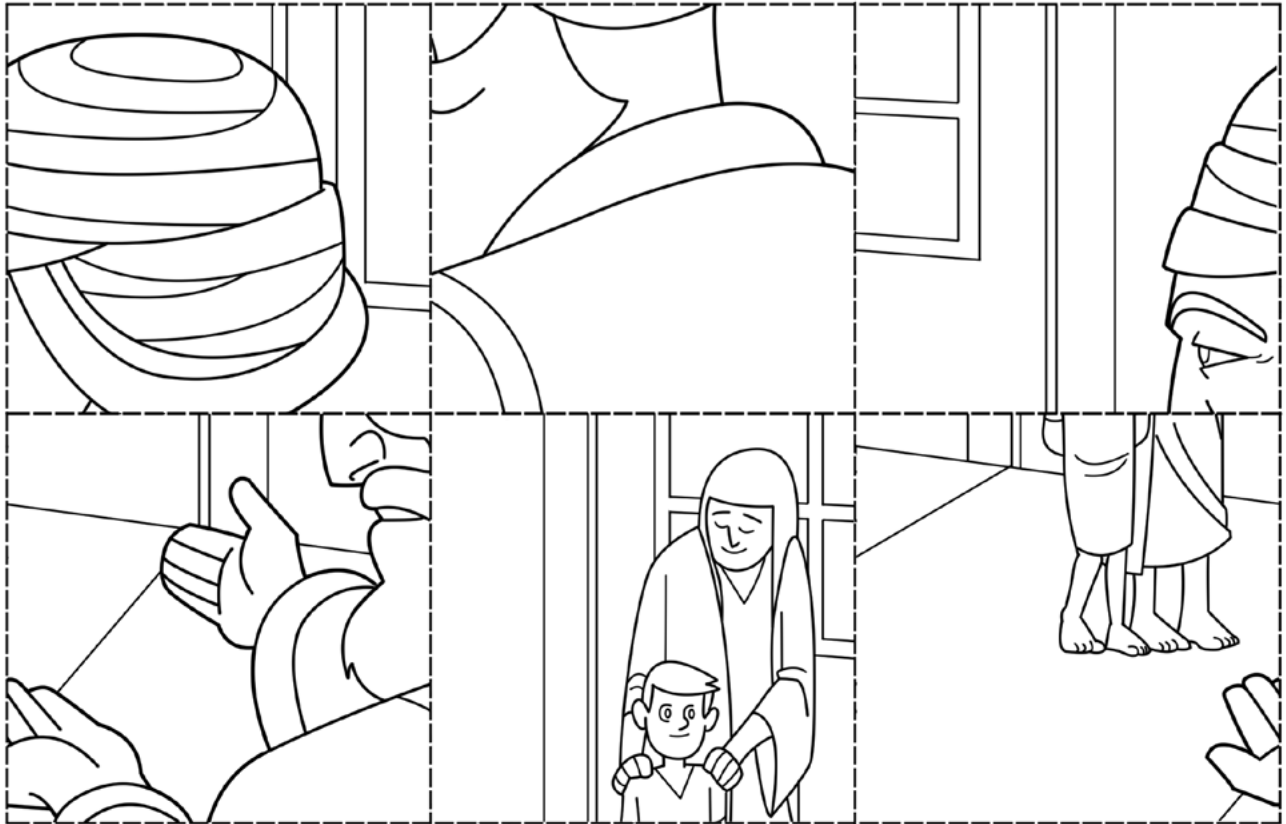

Samuel's mom gave him to the priests to raise. **1 Samuel 1: 24-28**



Cut-Paste-Color!

Cut along the dotted lines & arrange in order below.

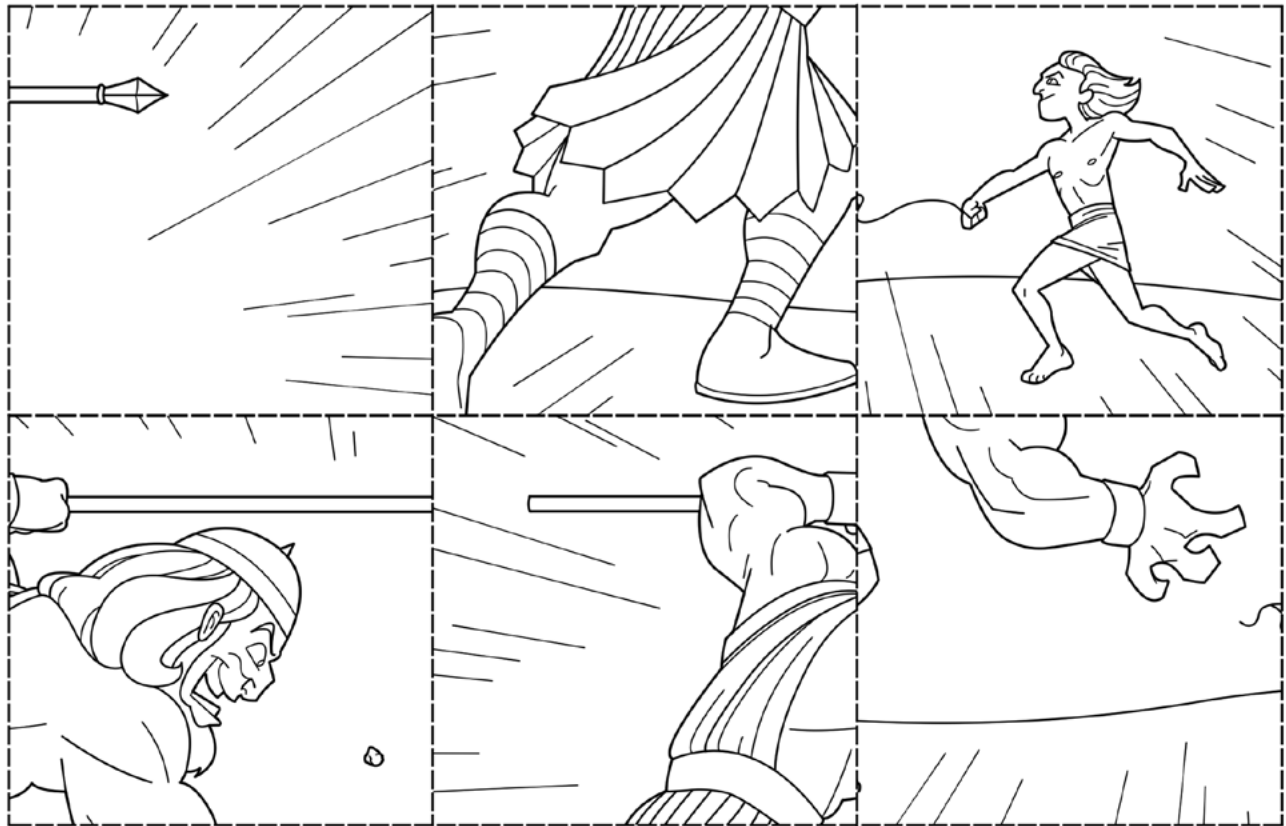

David takes on Goliath.

1 Samuel 17

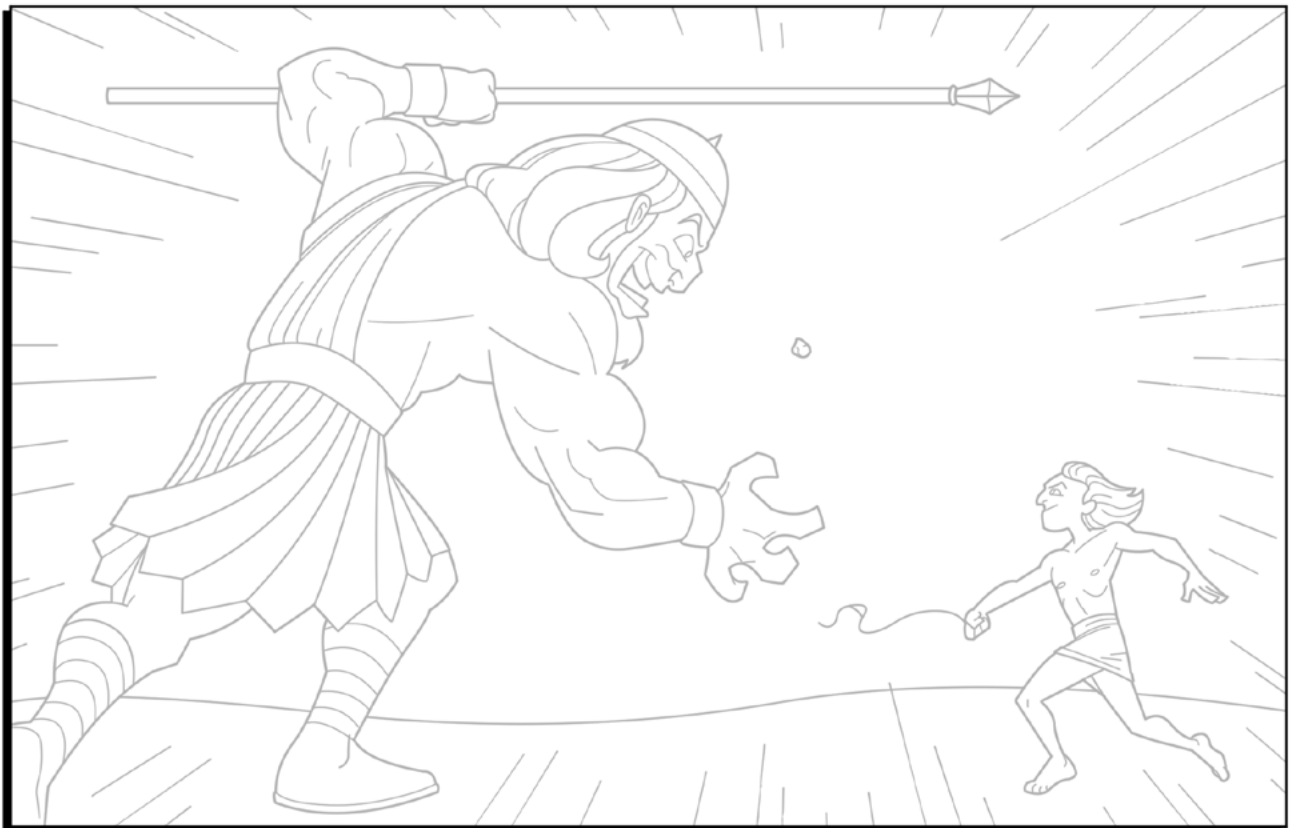

Cut-Paste-Color!

Cut along the dotted lines & arrange in order below.

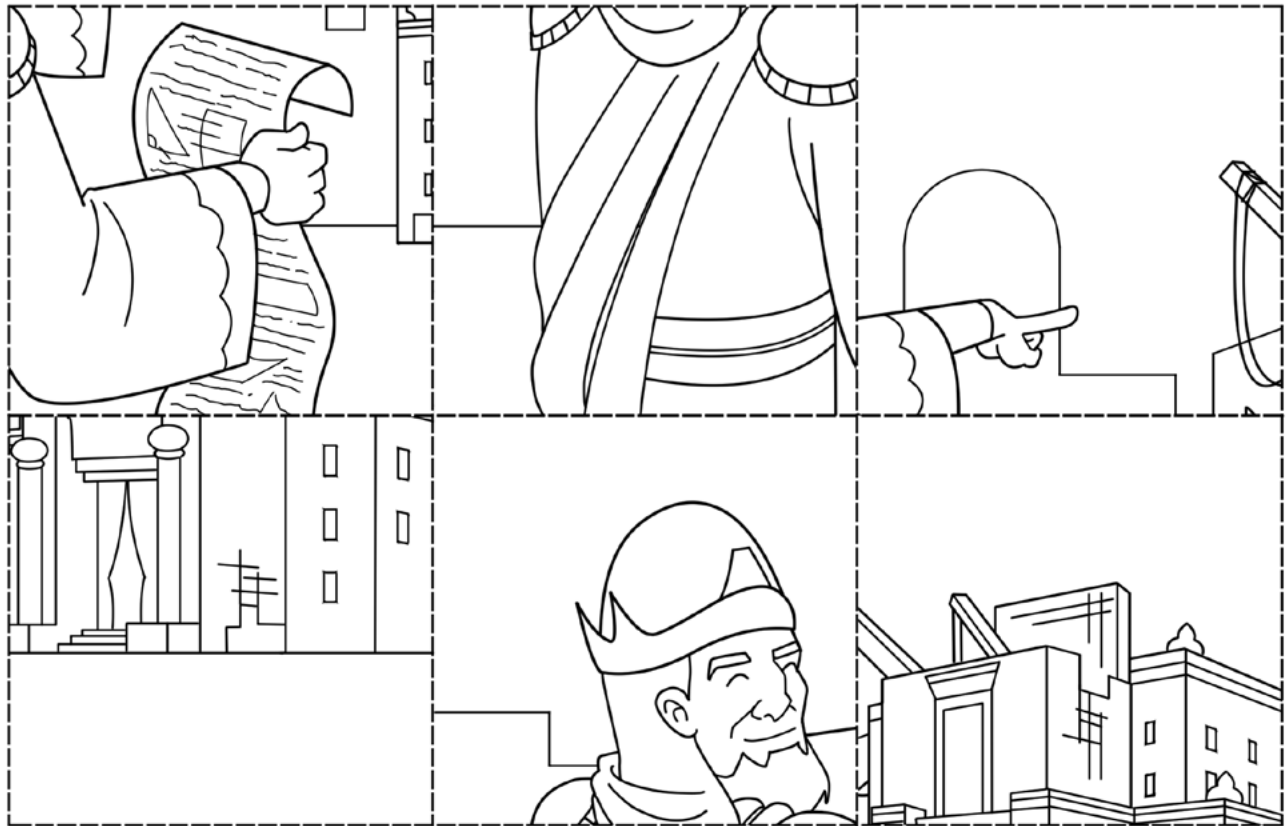

Solomon builds the temple.

1 Kings 6

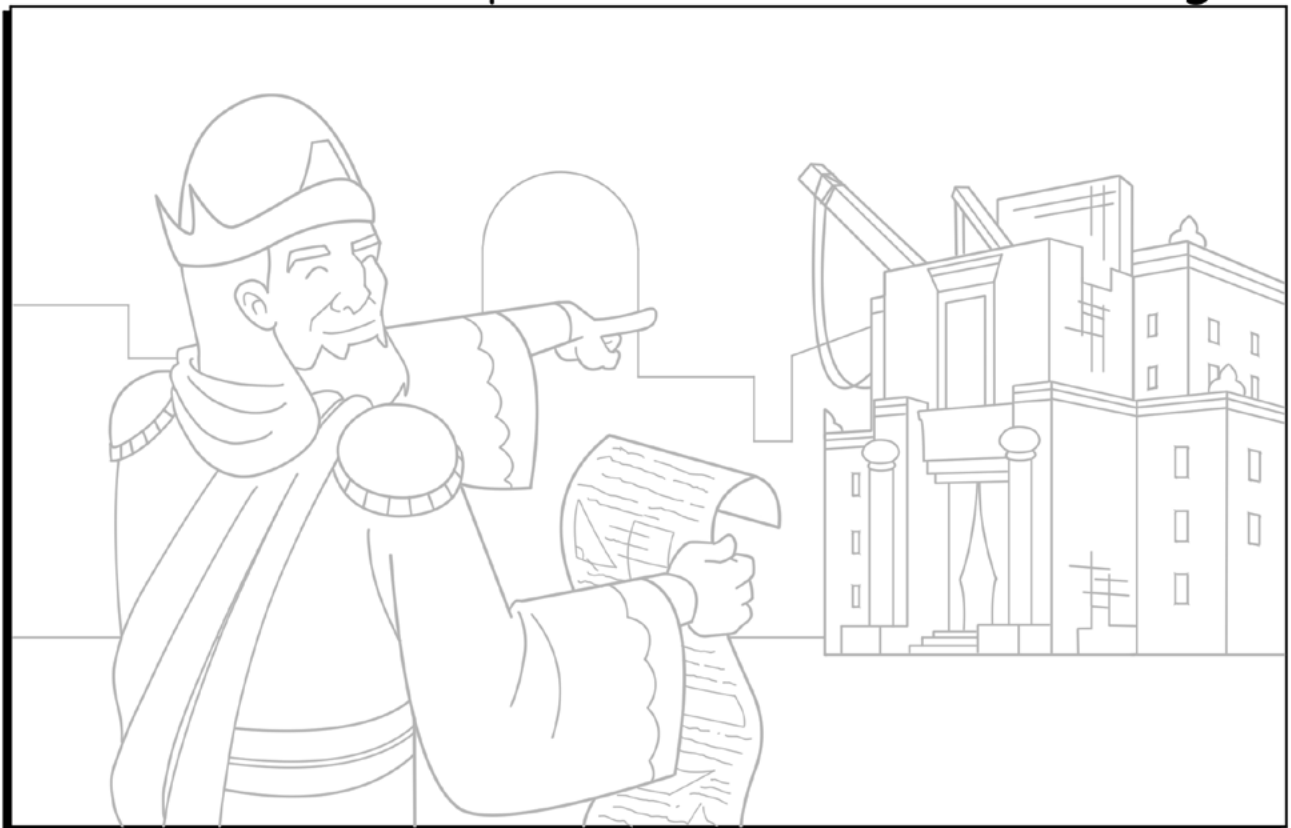

Cut-Paste-Color!

Cut along the dotted lines & arrange in order below.

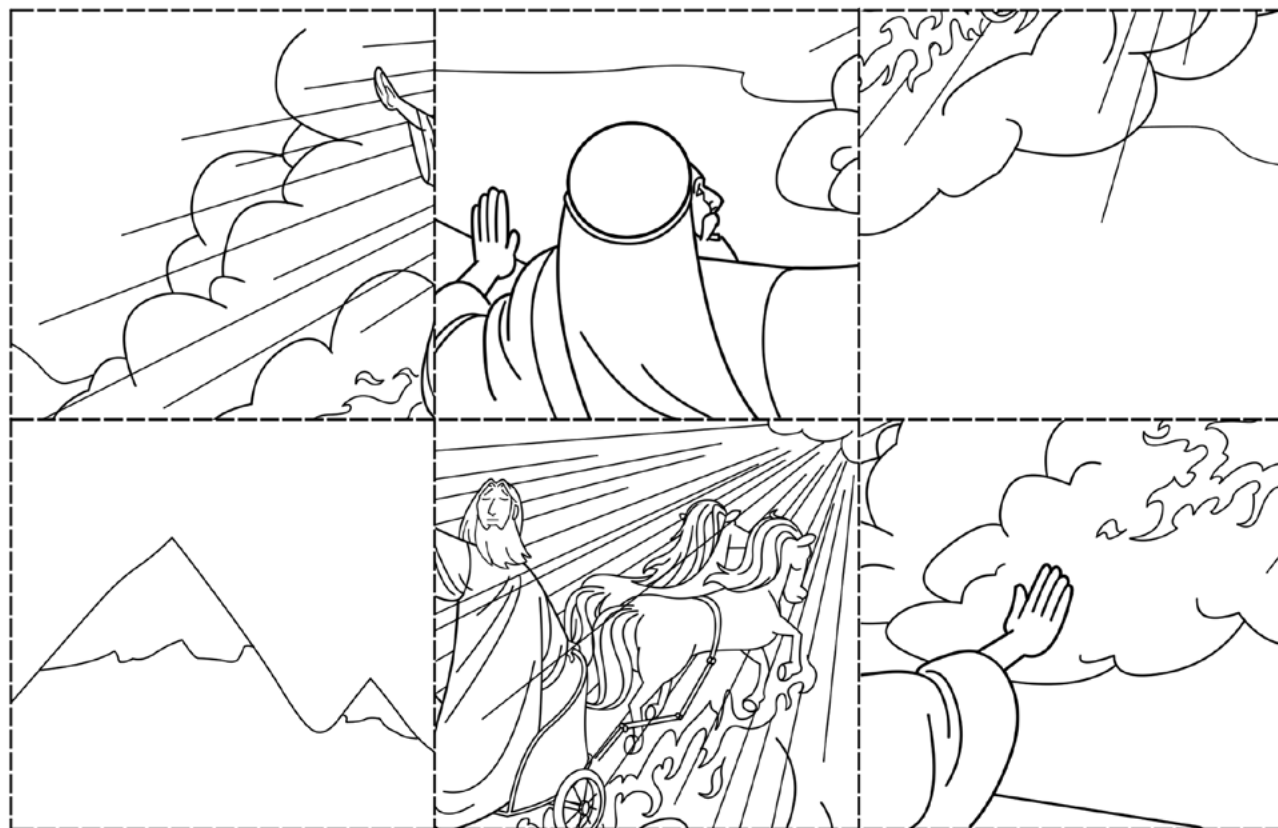

Elijah is taken up to heaven.

2 Kings 2



Cut-Paste-Color!

Cut along the dotted lines & arrange in order below.

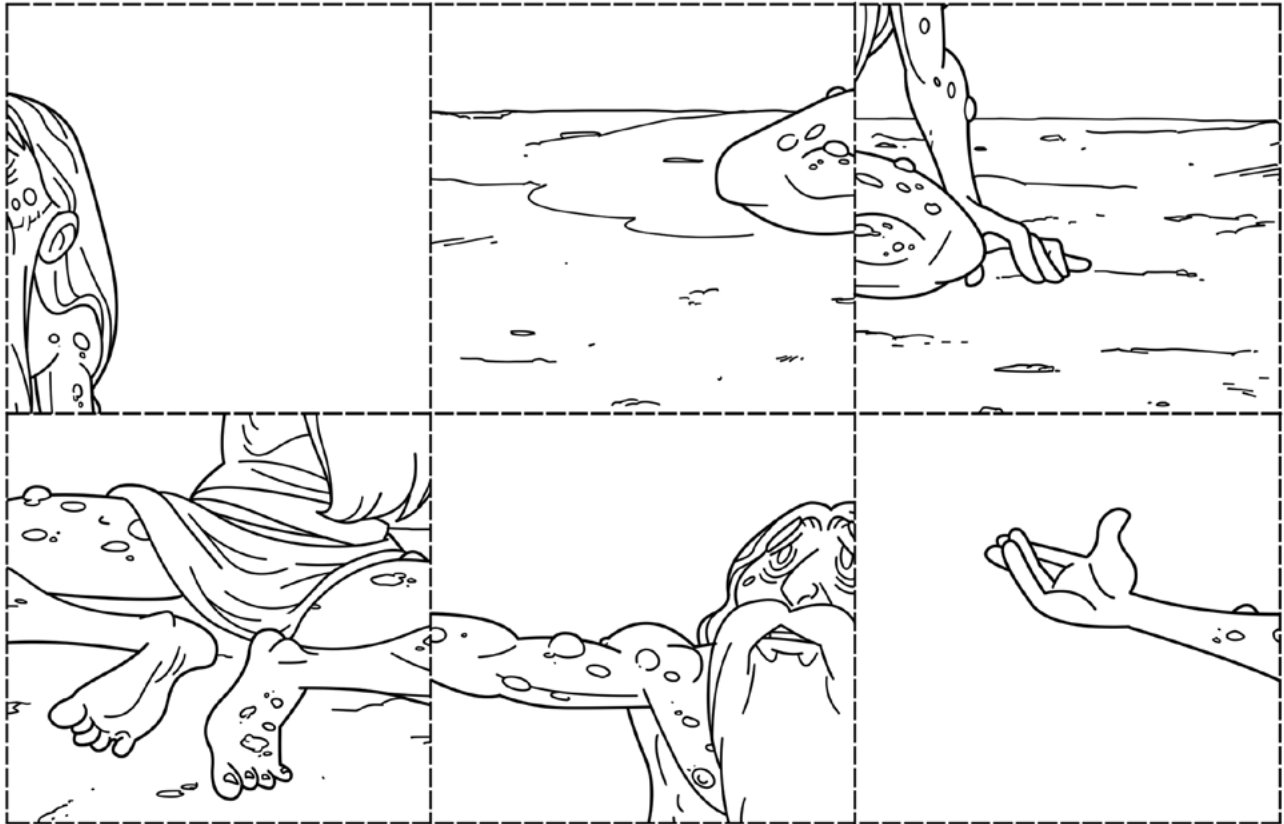

Job gets boils all over his body.

Job 2: 9-13

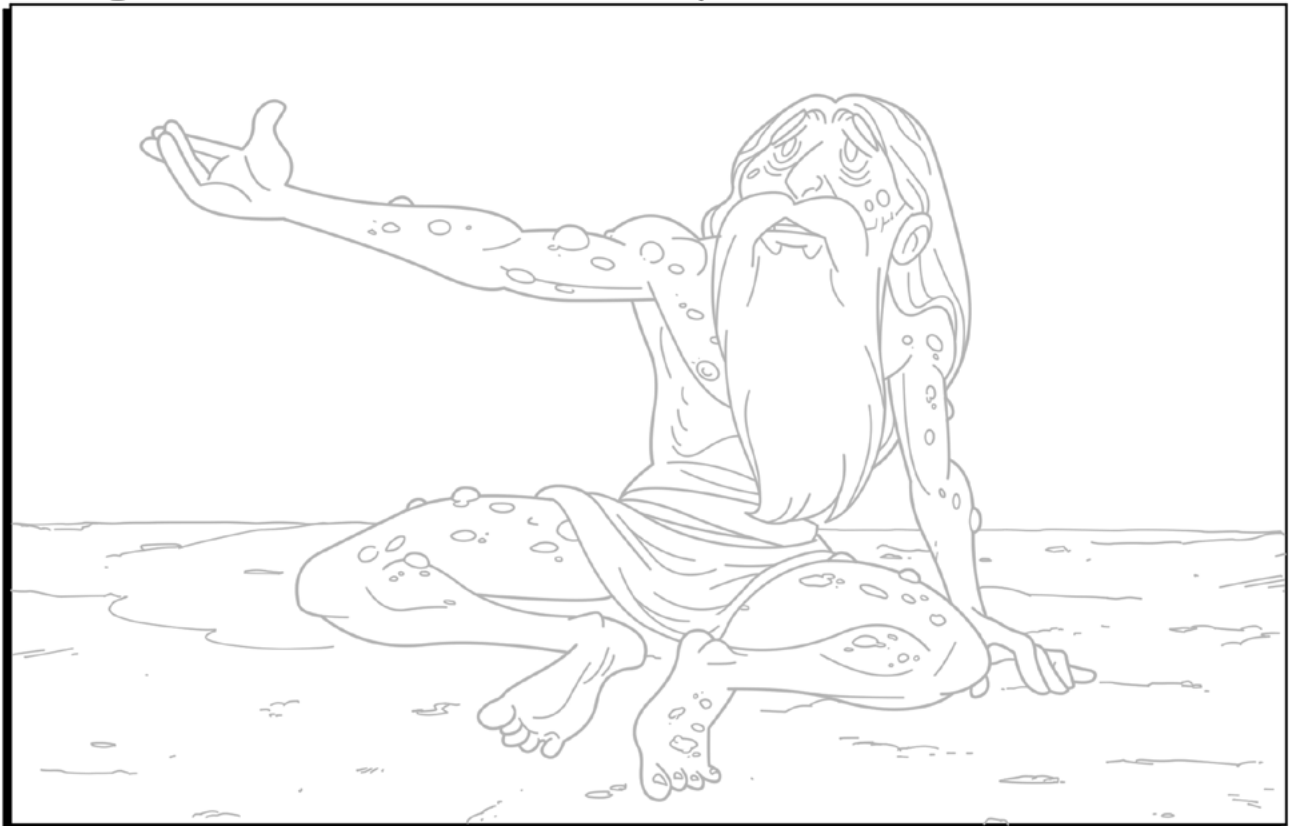

Cut-Paste-Color!

Cut along the dotted lines & arrange in order below.

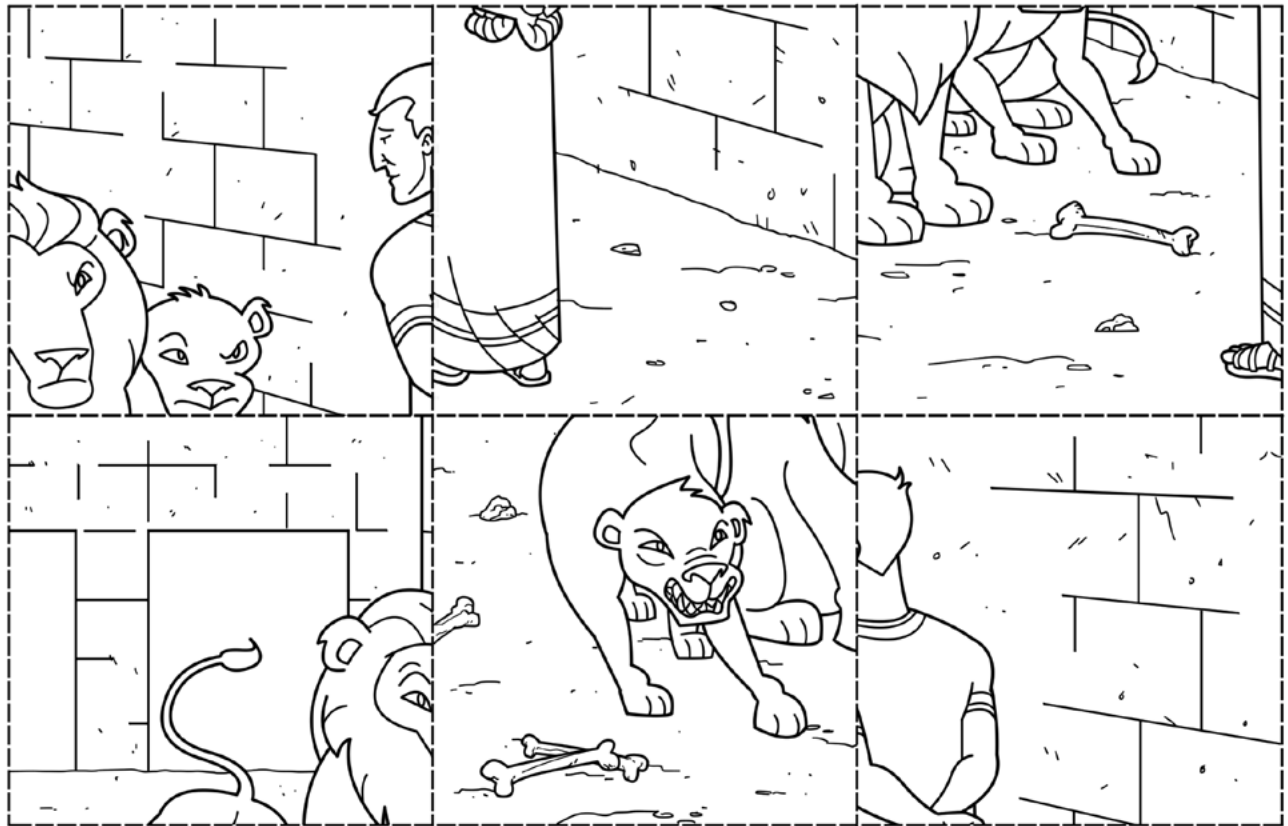

Daniel gets thrown in the lion's den.

Daniel 6

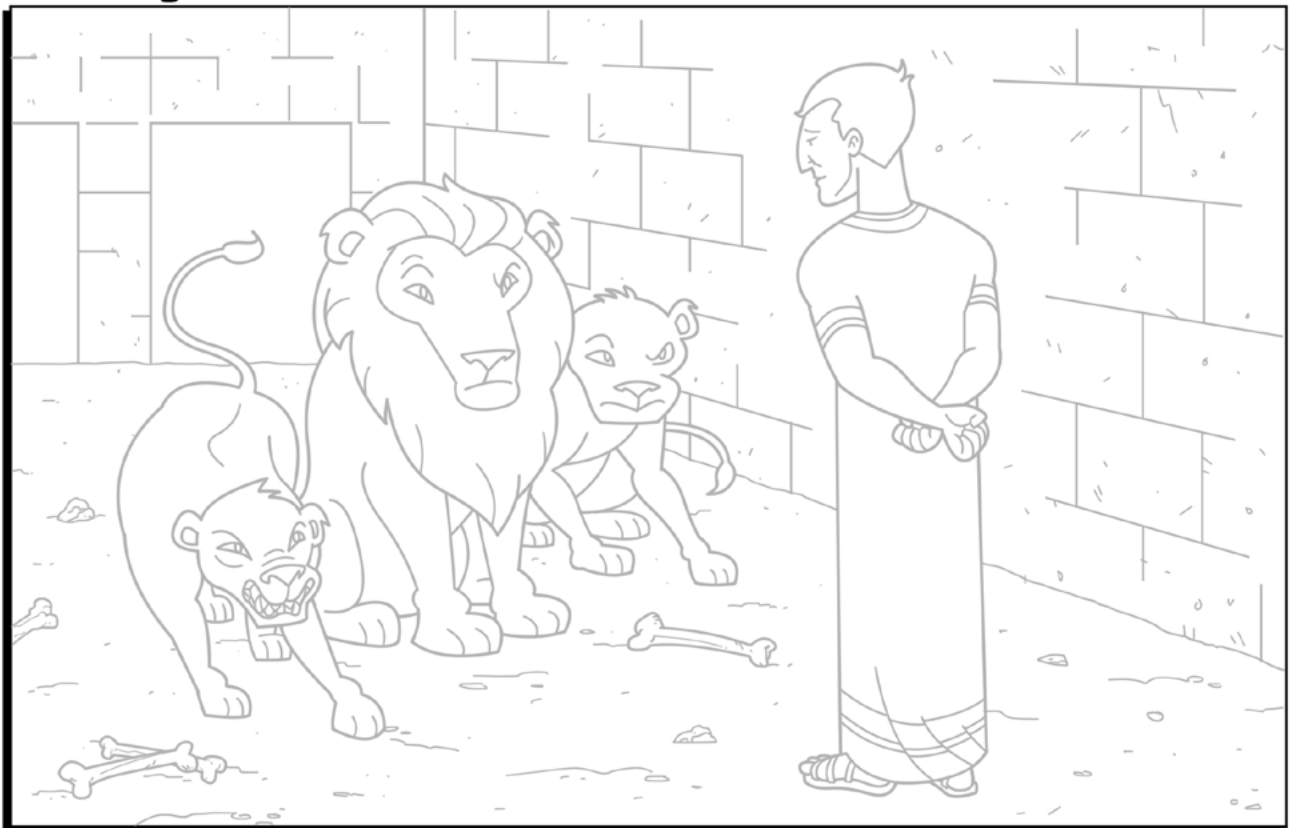

Cut-Paste-Color!

Cut along the dotted lines & arrange in order below.

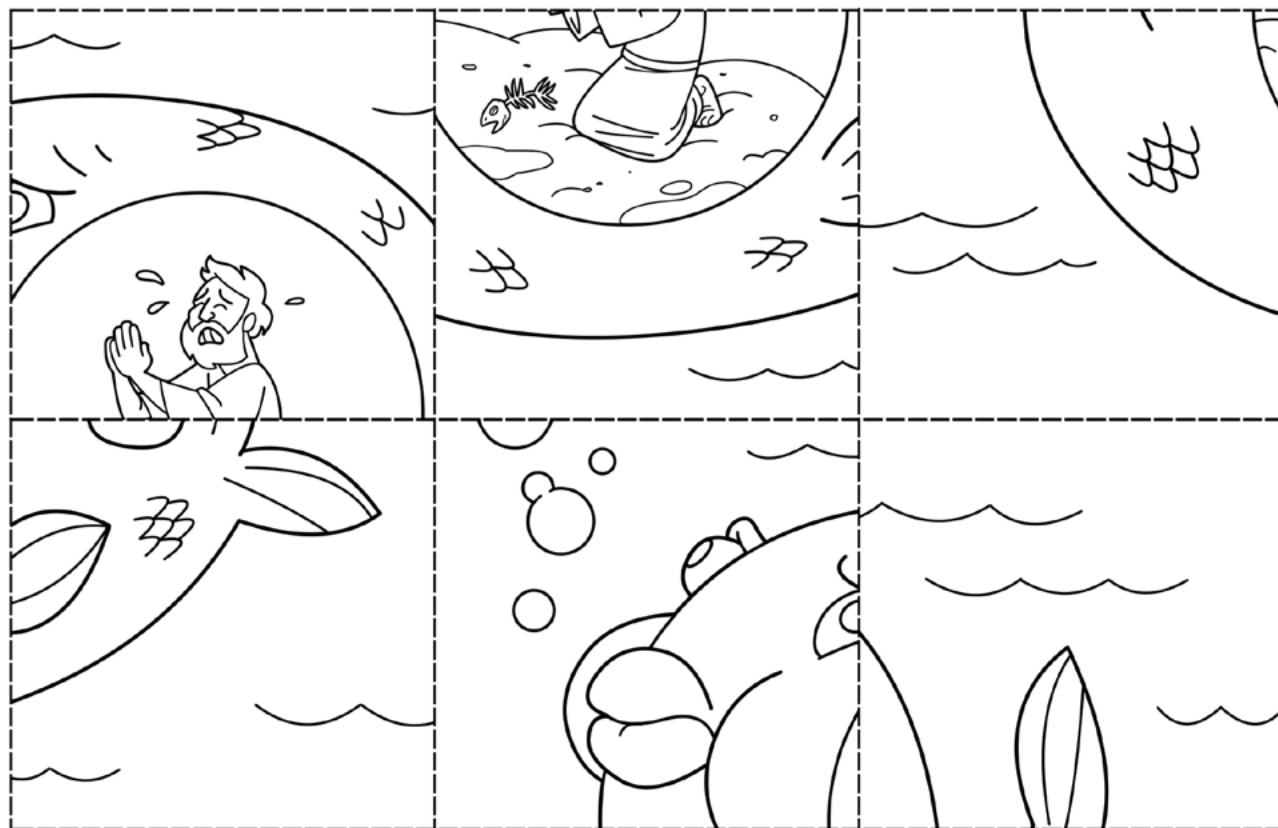

Jonah is swallowed by a big fish.

Jonah 1



Cut-Paste-Color!

Cut along the dotted lines & arrange in order below.

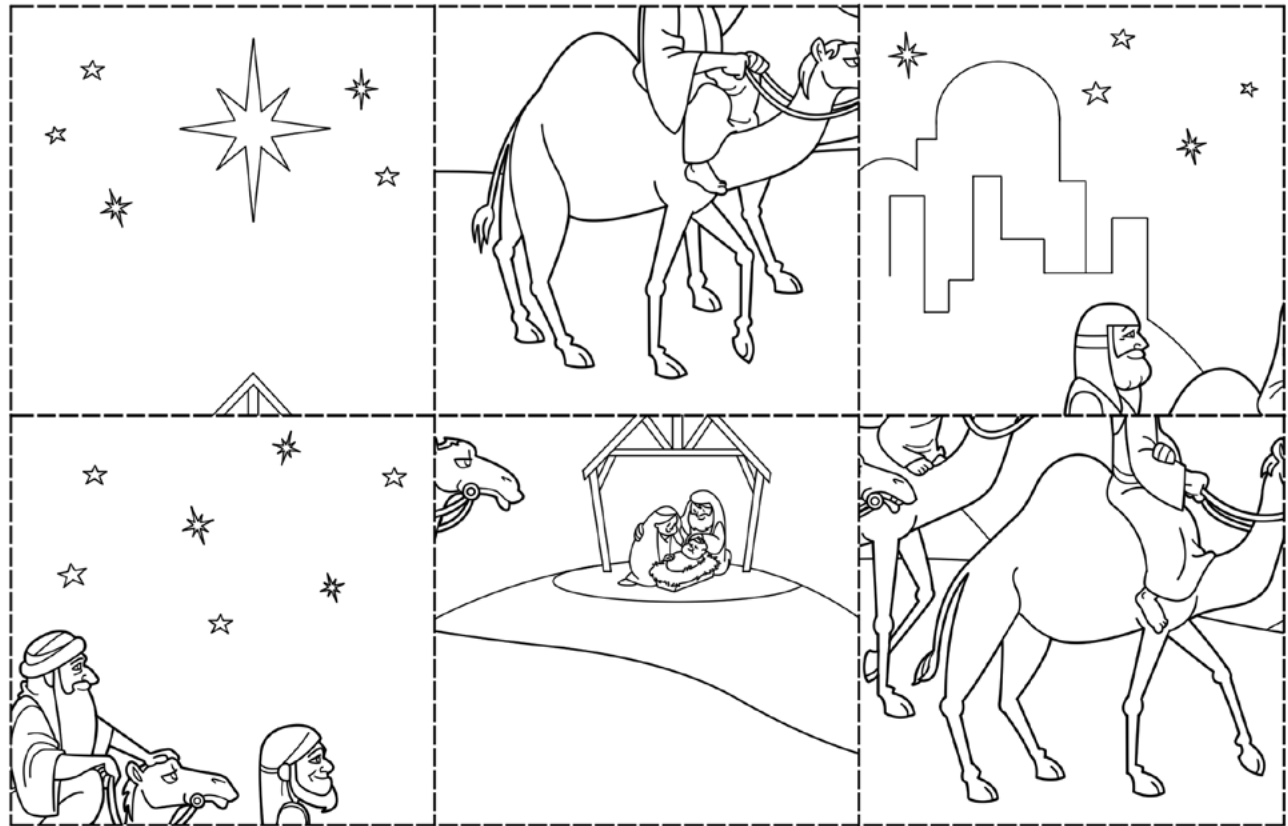

Jesus is born in Bethlehem.

Luke 2: 16-20



Cut-Paste-Color!

Cut along the dotted lines & arrange in order below.

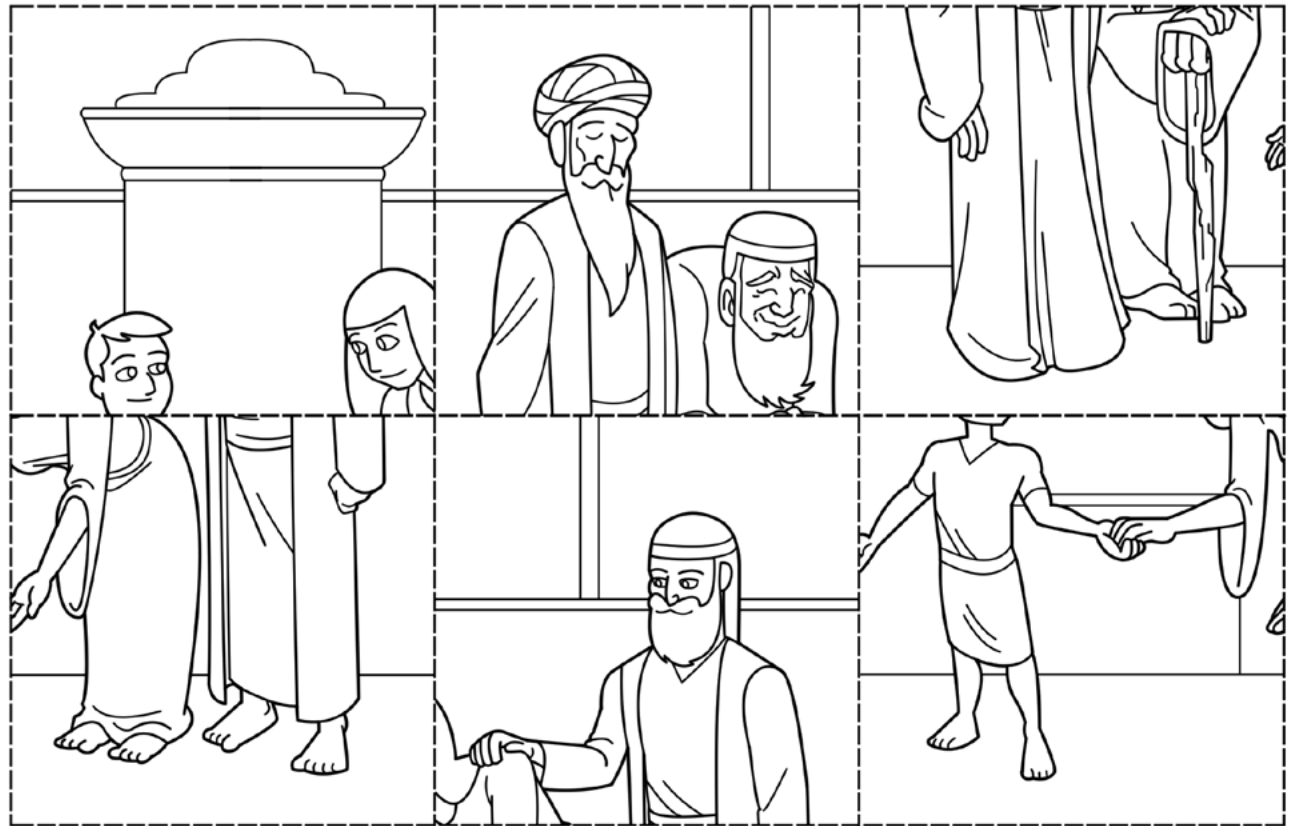

Jesus gets lost from his parents.

Luke 2: 41-48

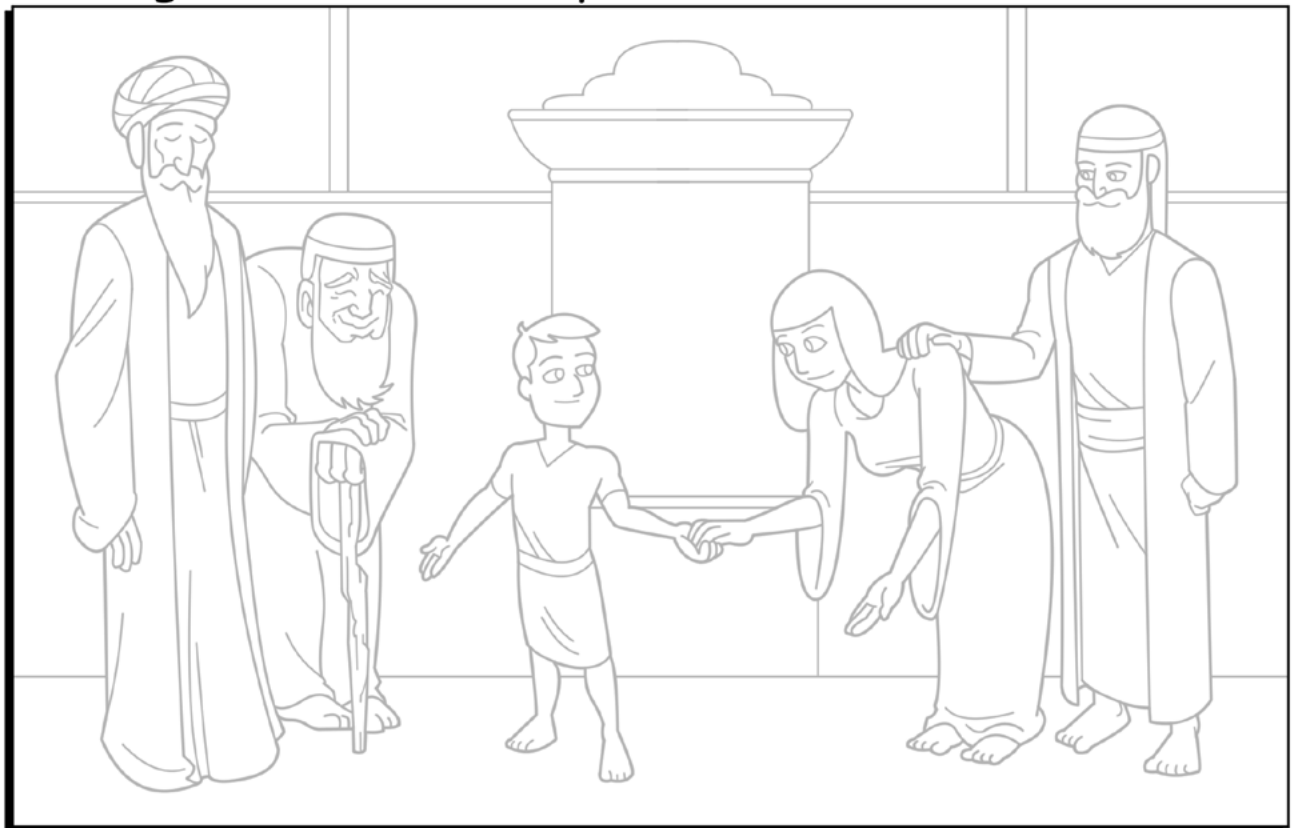

Cut-Paste-Color!

Cut along the dotted lines & arrange in order below.



Jesus heals the blind man.

Mark 8: 22-25



Cut-Paste-Color!

Cut along the dotted lines & arrange in order below.

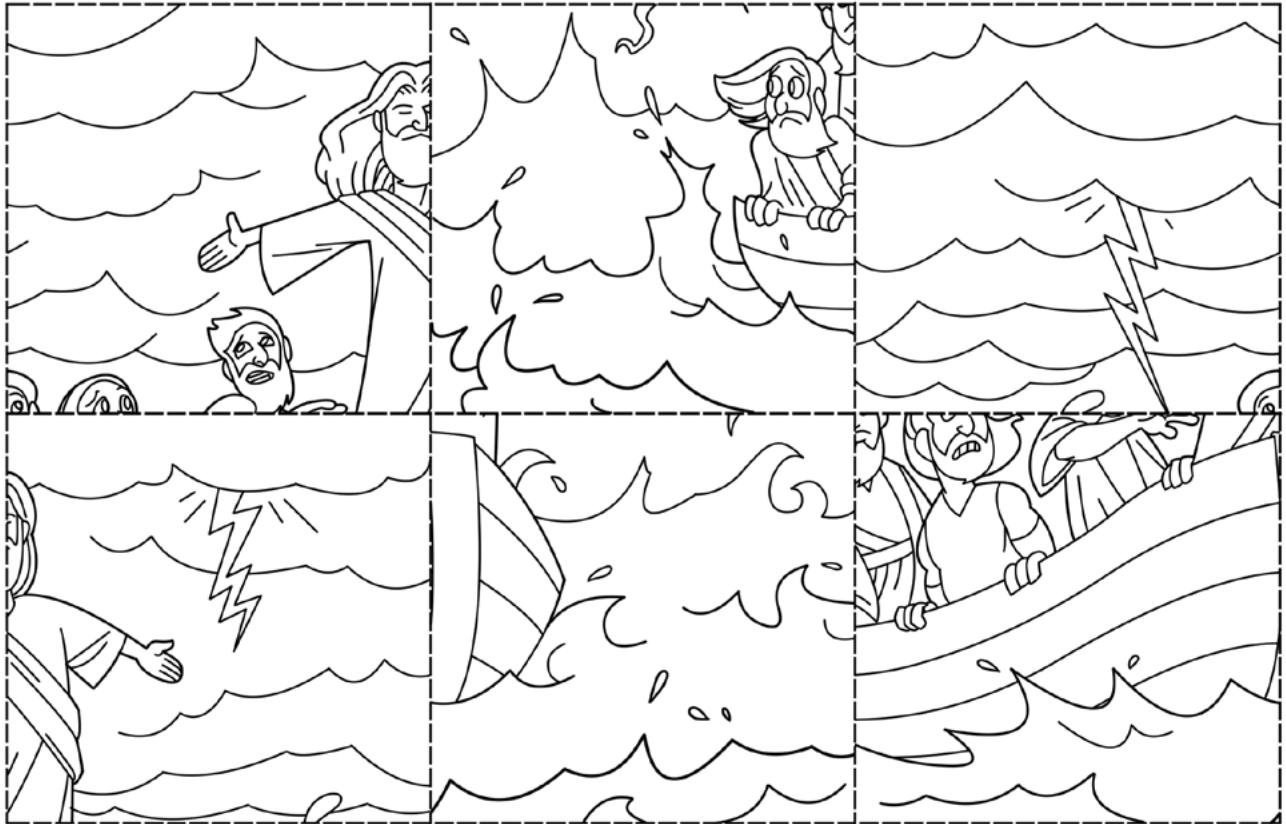

Jesus calms the storm.

Mark 4: 35-41



Cut-Paste-Color!

Cut along the dotted lines & arrange in order below.

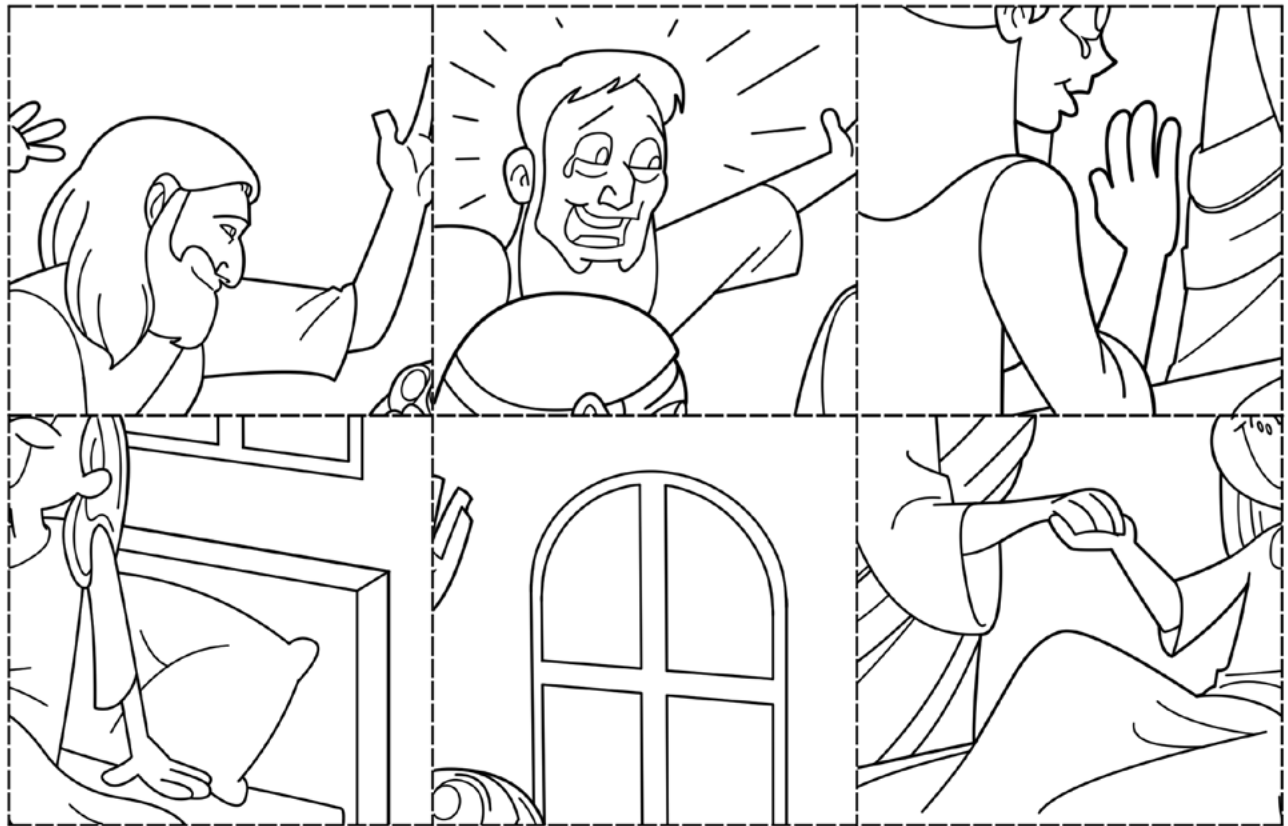

Jesus raises the little girl.

Luke 8: 40-56



Cut-Paste-Color!

Cut along the dotted lines & arrange in order below.

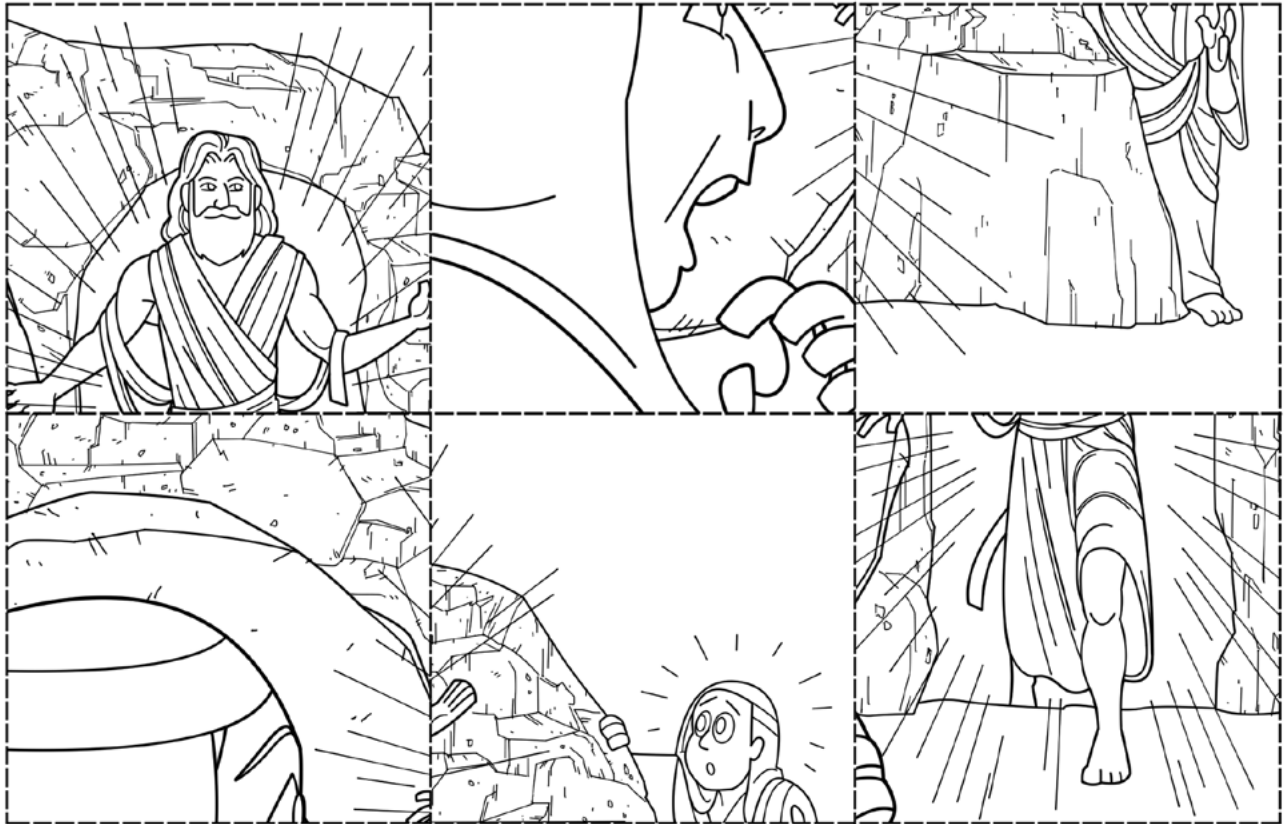

Jesus arises on the third day.

Luke 24



Cut-Paste-Color!

Cut along the dotted lines & arrange in order below.

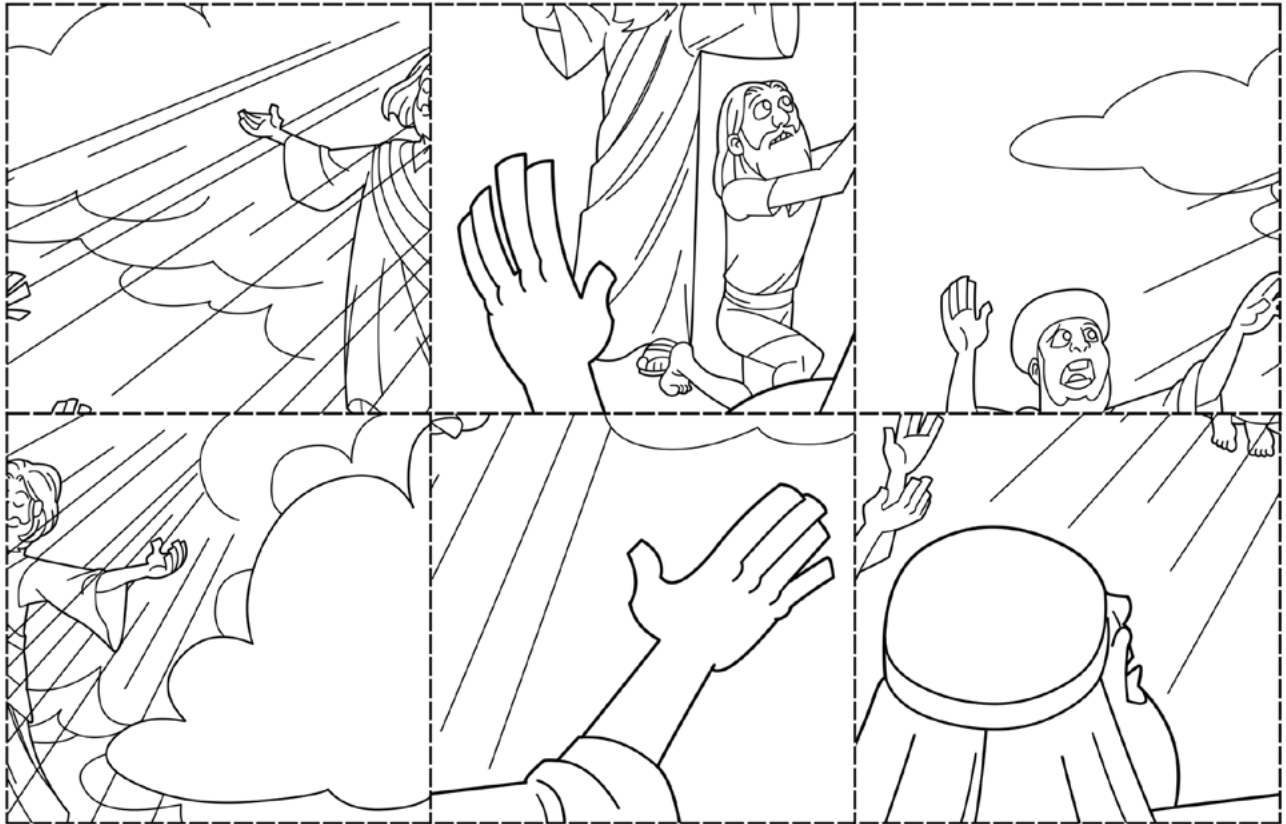

Jesus ascends into heaven.

Acts 1

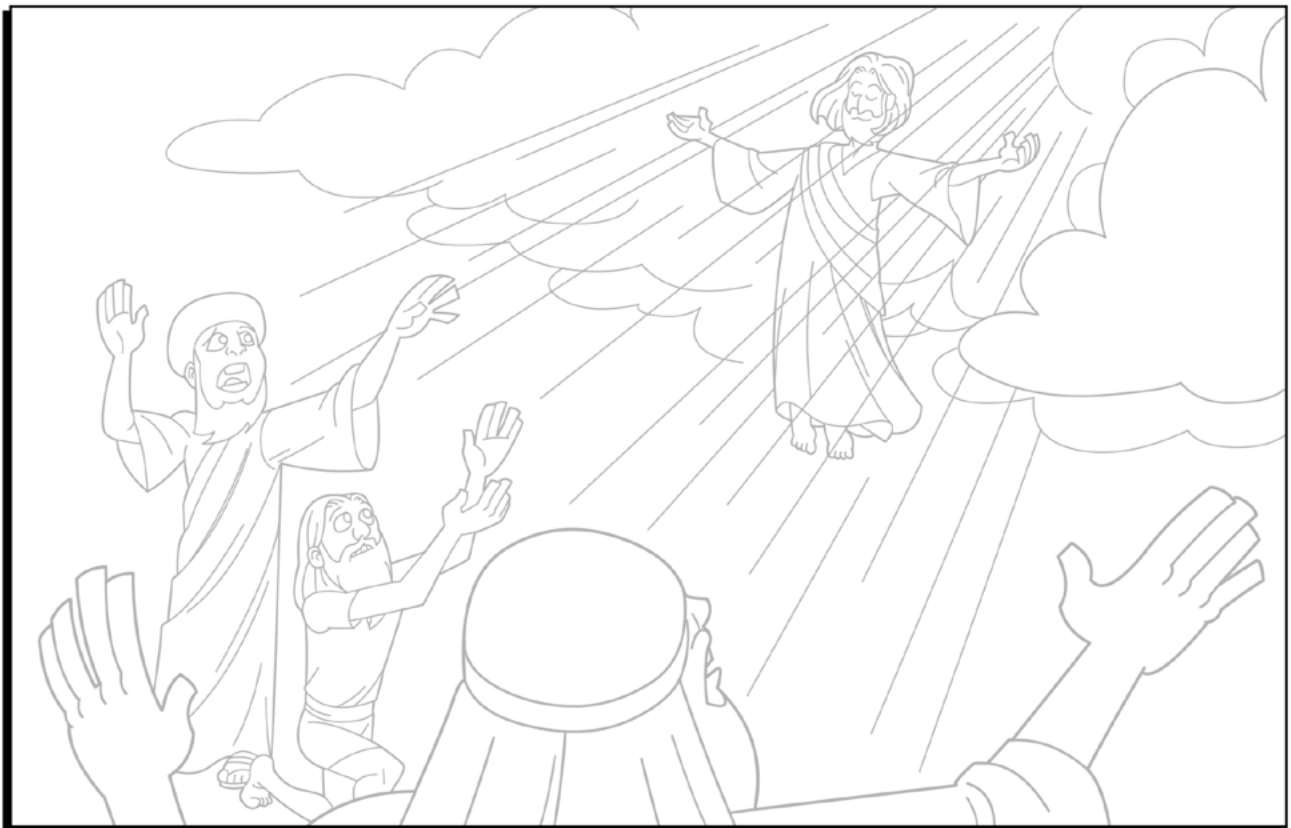

COLOR BY NUMBERS



Color by Numbers!

1 = Green

2 = Light blue

3 = Yellow

4 = Brown

5 = Red

6 = Skin tone

7 = Black

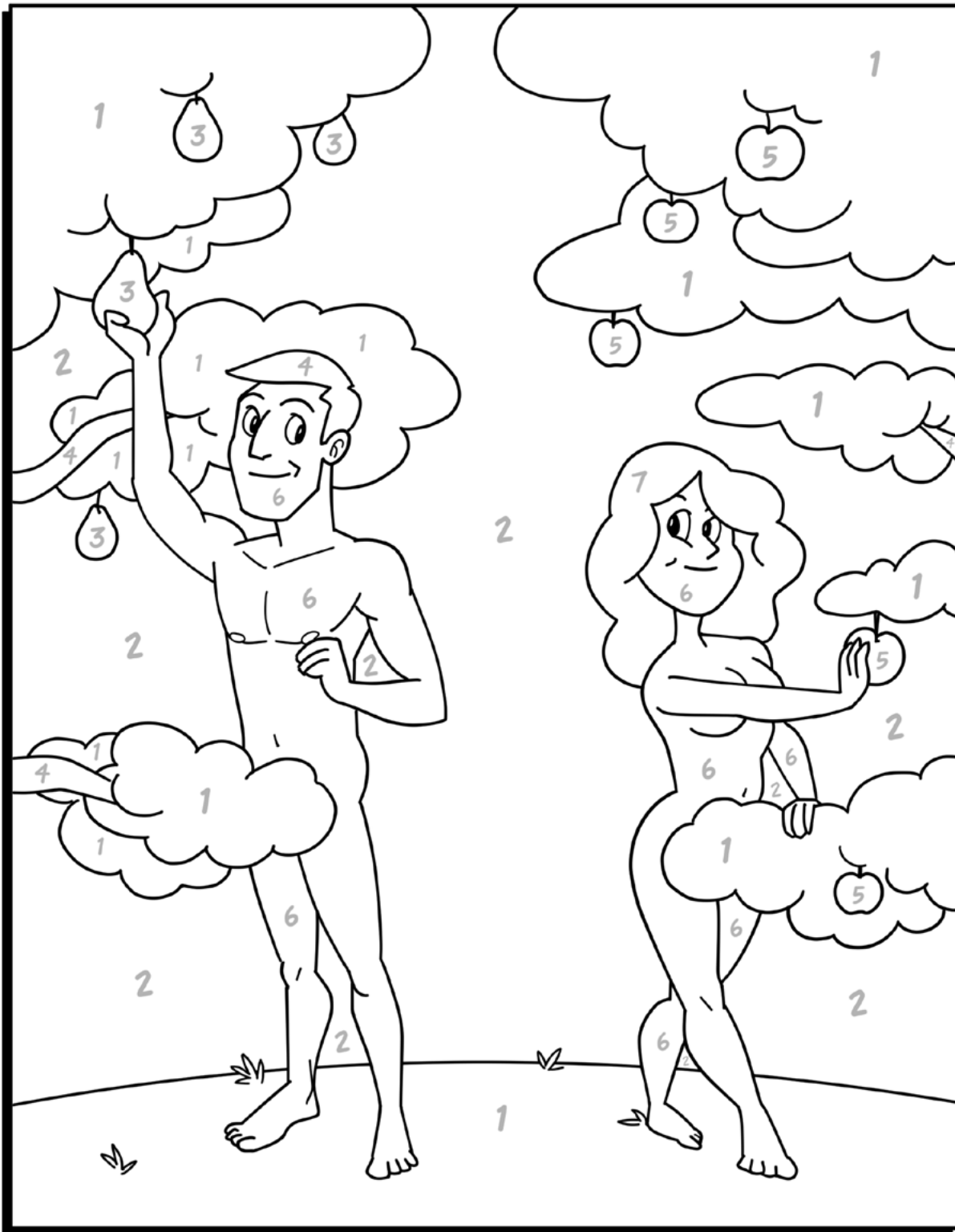

In the Garden, Adam and Eve see each other.

Genesis 2

Color by Numbers!

1 = Yellow

3 = Dark green

5 = Brown

7 = Purple

2 = Dark blue

4 = Gray

6 = Skin tone

8 = Red

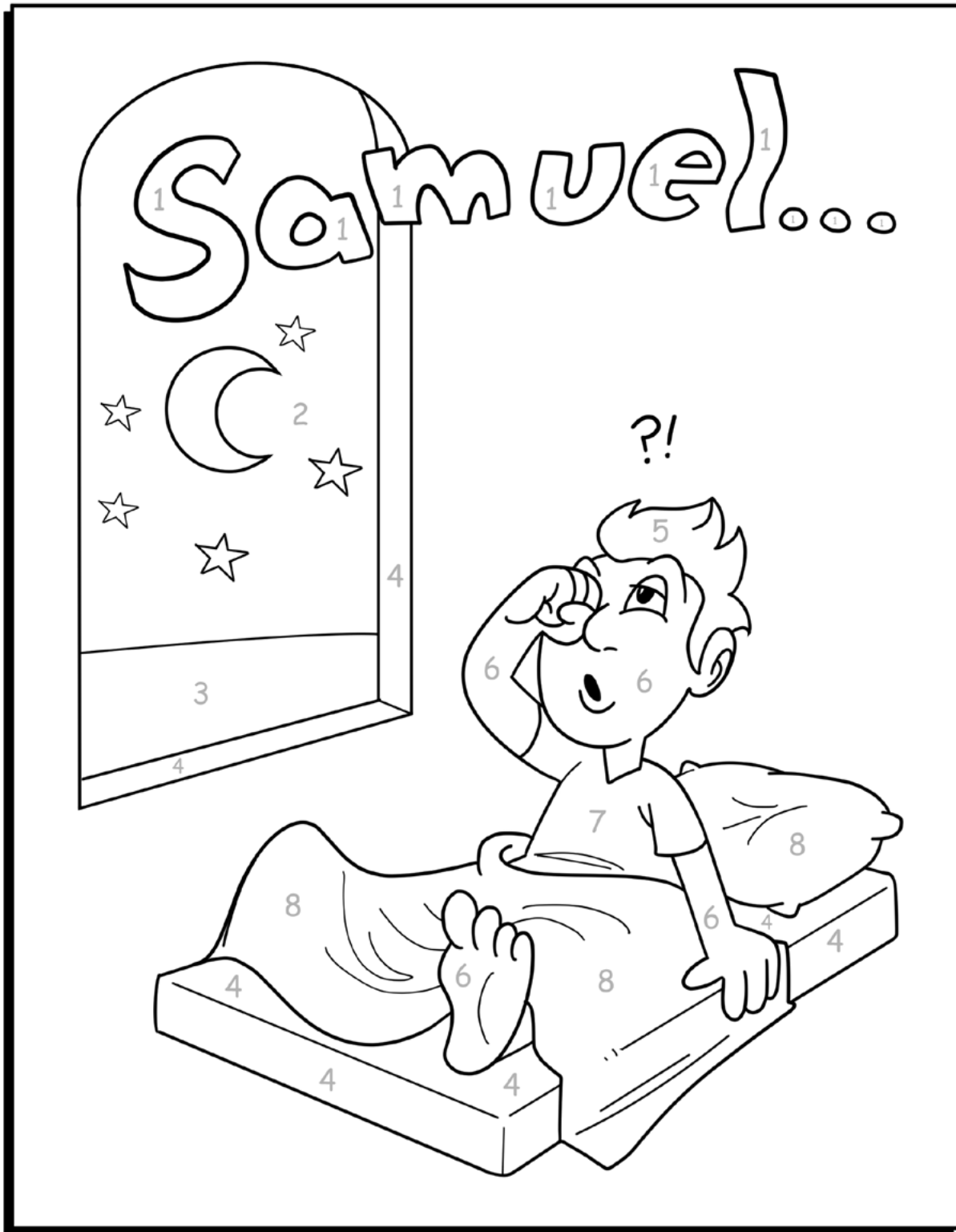

Samuel hears God calling in his sleep.

1 Samuel 3

Color by Numbers!

1 = Red
2 = Blue

3 = Orange
4 = Yellow

5 = Brown
6 = Skin tone

7 = Purple
8 = Green

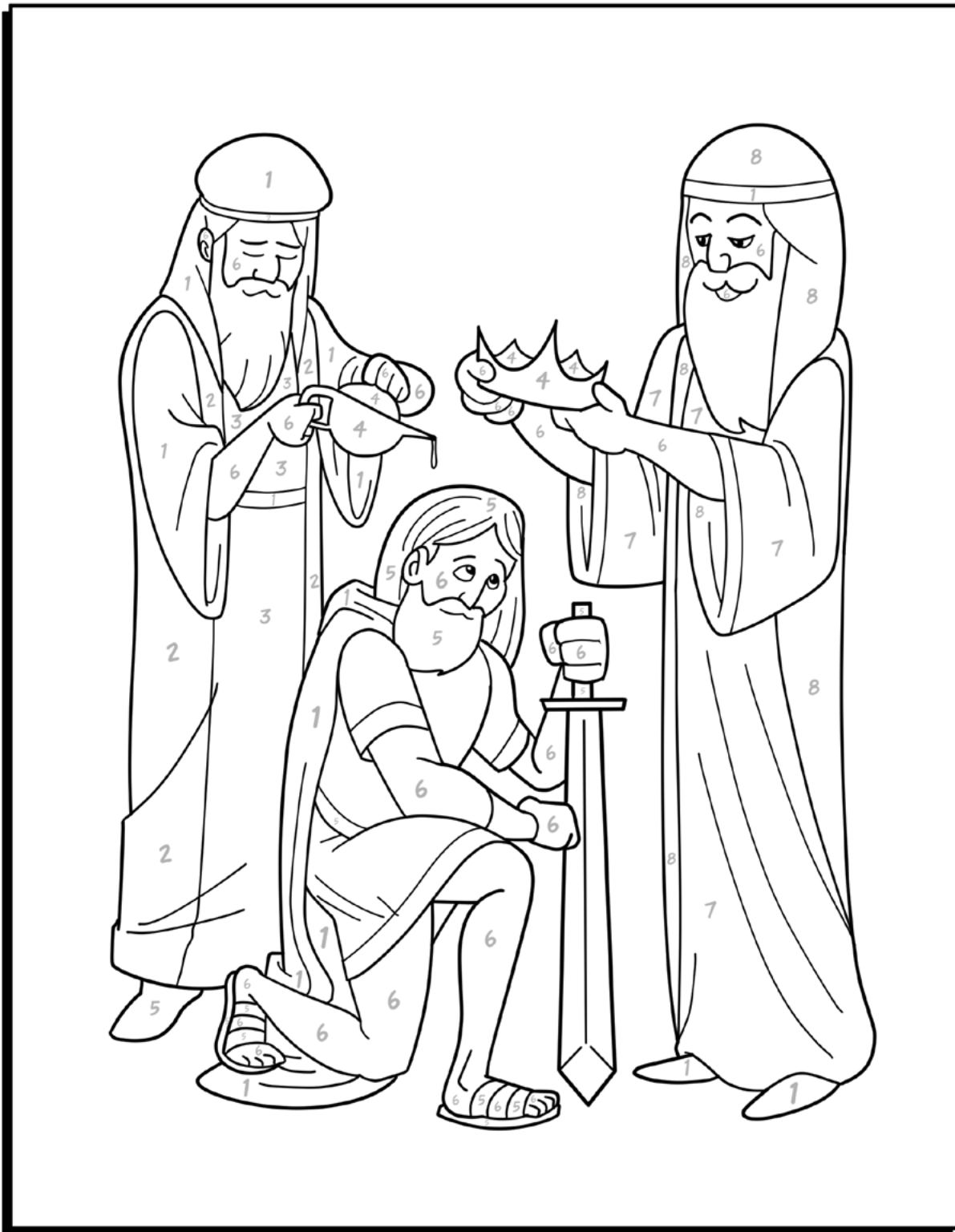

David is crowned King of Israel.

2 Samuel 5

Color by Numbers!

1 = Brown
2 = Purple

3 = Blue
4 = Orange

5 = Yellow
6 = Skin tone

7 = Black
8 = Gray

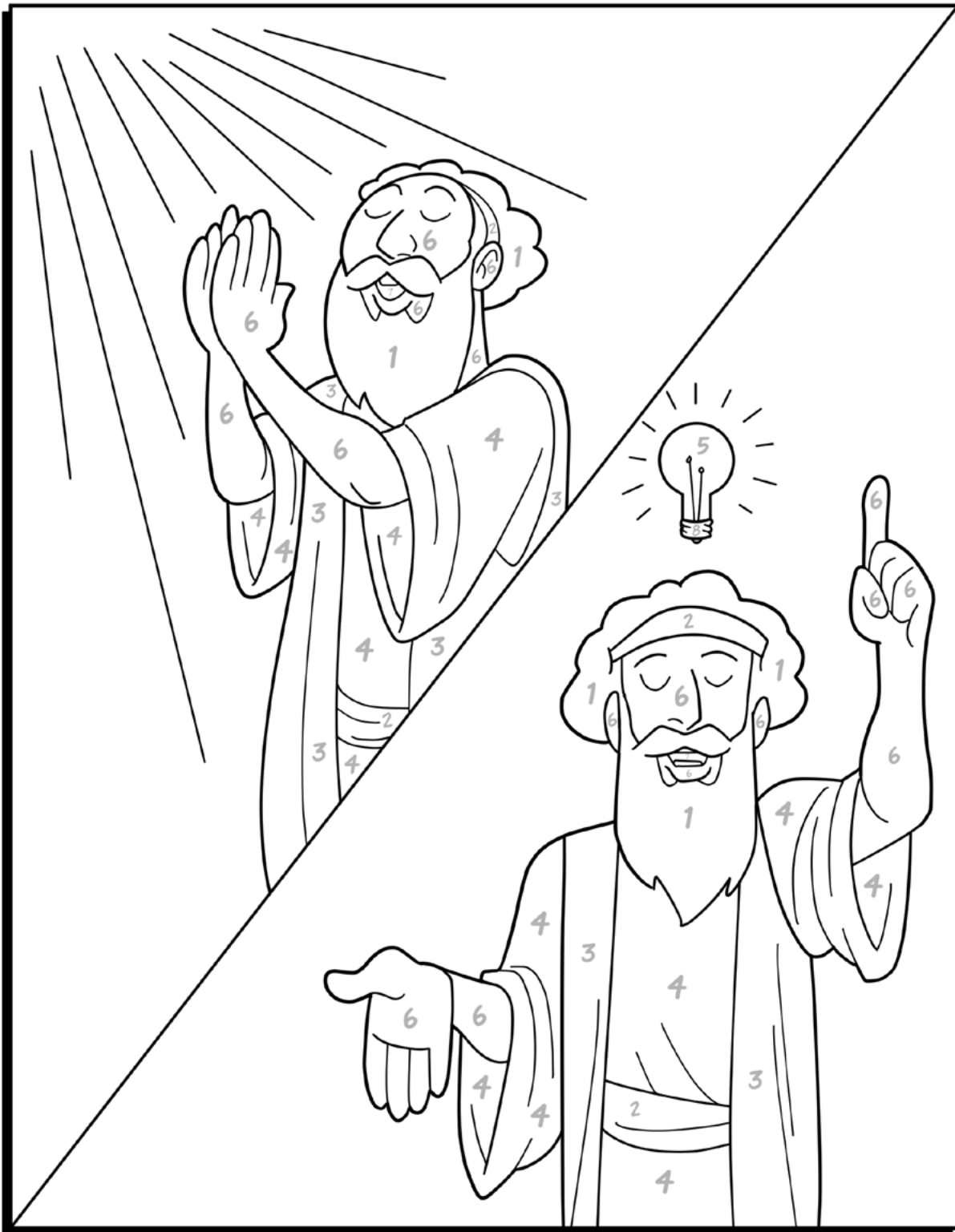

Solomon prays for wisdom and becomes the wisest man ever.

1 Kings 3

Color by Numbers!

1 = Gray

3 = Yellow

5 = Dark blue

7 = Green

9 = Brown

2 = Orange

4 = Light blue

6 = Skin tone

8 = Red

10 = Purple



Elijah asks God for fire on an altar drenched in water.

1 Kings 18

Color by Numbers!

1 = Black

2 = Light blue

3 = Purple

4 = Red

5 = Orange

6 = Skin tone

7 = Brown

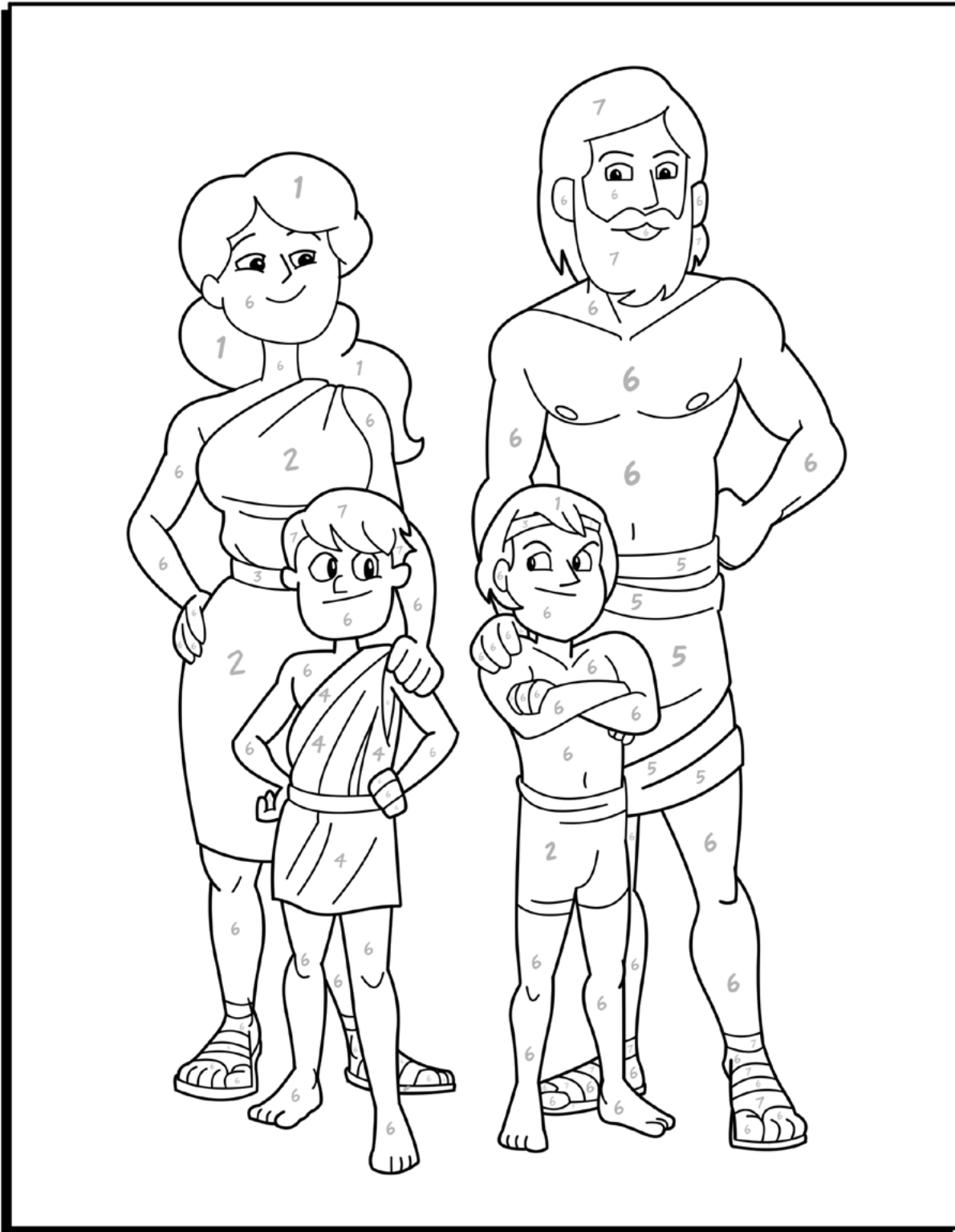

Cain and Abel, the first children on Earth. **Genesis 4**

Color by Numbers!

1 = Red

3 = Yellow

5 = Blue

7 = Light blue

9 = Gray

2 = Orange

4 = Green

6 = Purple

8 = Brown

10 = Skin tone

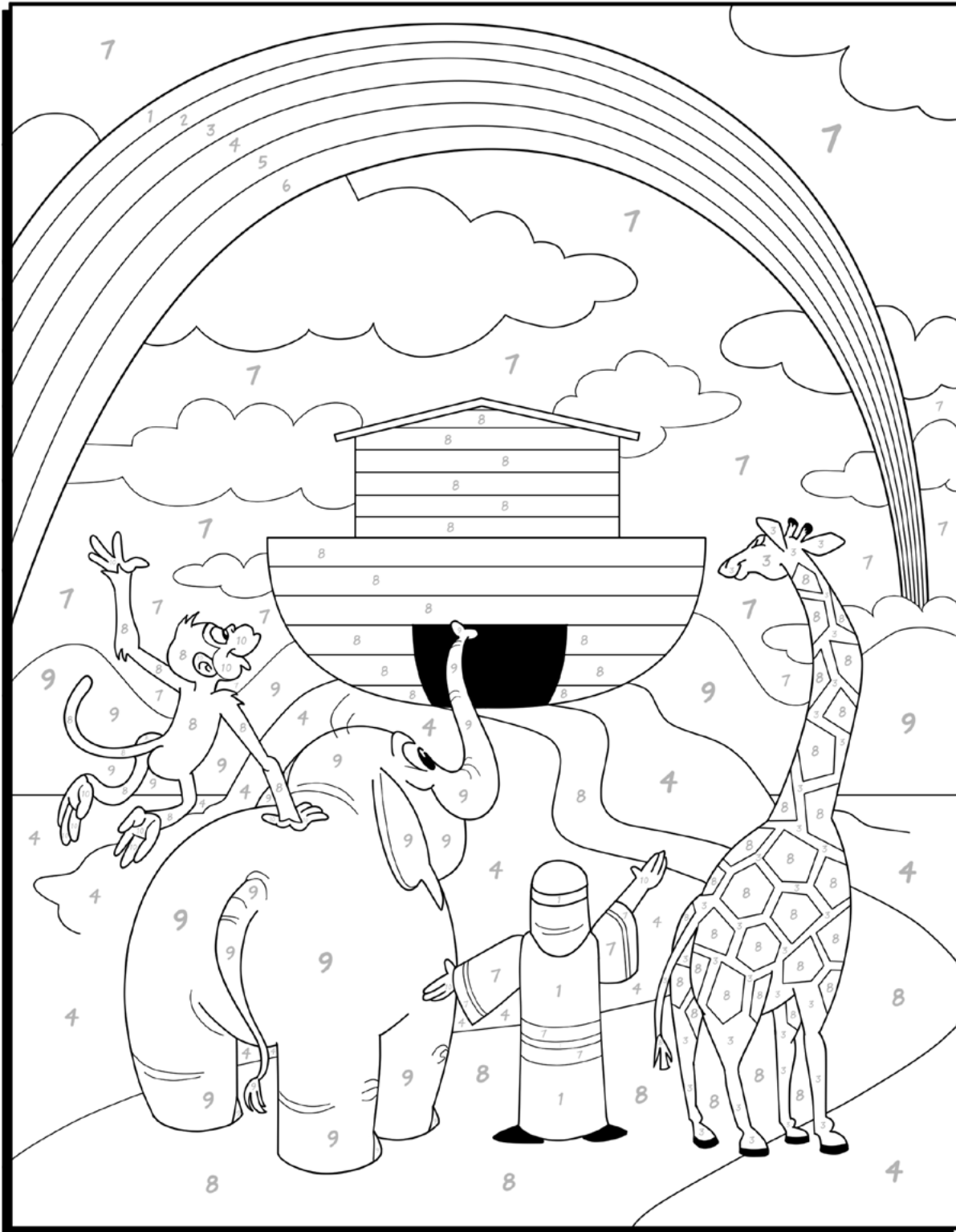

Noah and the animals see a beautiful rainbow.

Genesis 9

Color by Numbers!

1 = Light blue
2 = Yellow

3 = Dark green
4 = Brown

5 = Blue
6 = Skin tone

7 = Red
8 = Purple

9 = Gray
10 = Black



Jacob's ladder reached to heaven.

Genesis 28

Color by Numbers!

1 = Light blue

3 = Blue

5 = Yellow

7 = Brown

9 = Green

2 = Purple

4 = Red

6 = Skin tone

8 = Gray

10 = Black



Deborah leads the army to victory.

Judges 4

Color by Numbers!

1 = Orange
2 = Yellow

3 = Light blue
4 = Brown

5 = Purple
6 = Skin tone

7 = Gray
8 = Red



Moses sees the burning bush.

Exodus 3

Color by Numbers!

1 = Gray

3 = Blue

5 = Yellow

7 = Purple

2 = Dark blue

4 = Brown

6 = Skin tone

8 = Red

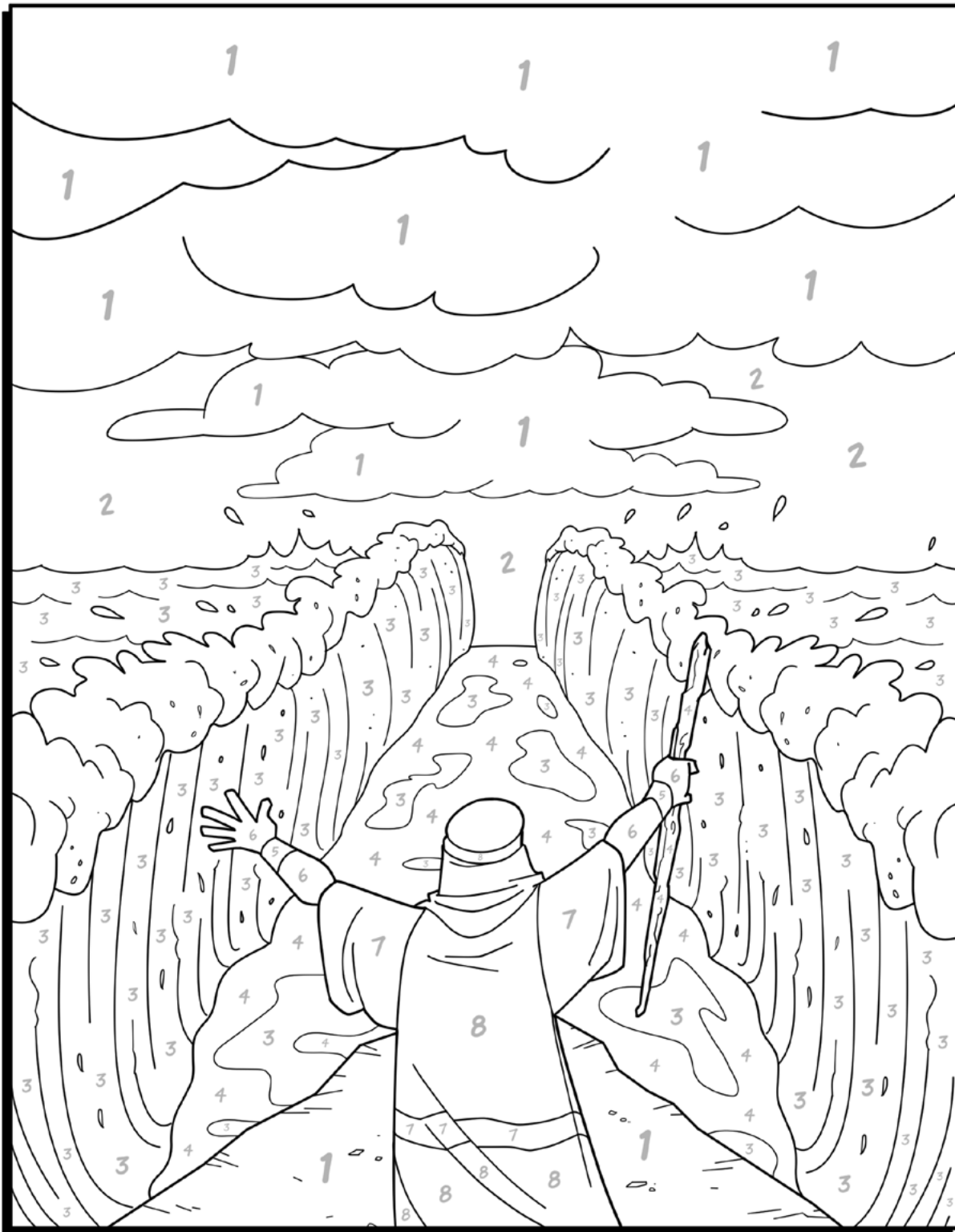

Moses parts The Red Sea so the people can escape.

Exodus 3

Color by Numbers!

1 = Black

3 = Yellow

5 = Pink

7 = Purple

2 = Skin tone

4 = Orange

6 = Brown



Samson defeats the lion.

Judges 14

Color by Numbers!

1 = Brown

3 = Blue

5 = Black

7 = Red

9 = Purple

2 = Pink

4 = Light blue

6 = Skin tone

8 = Green

10 = Gray

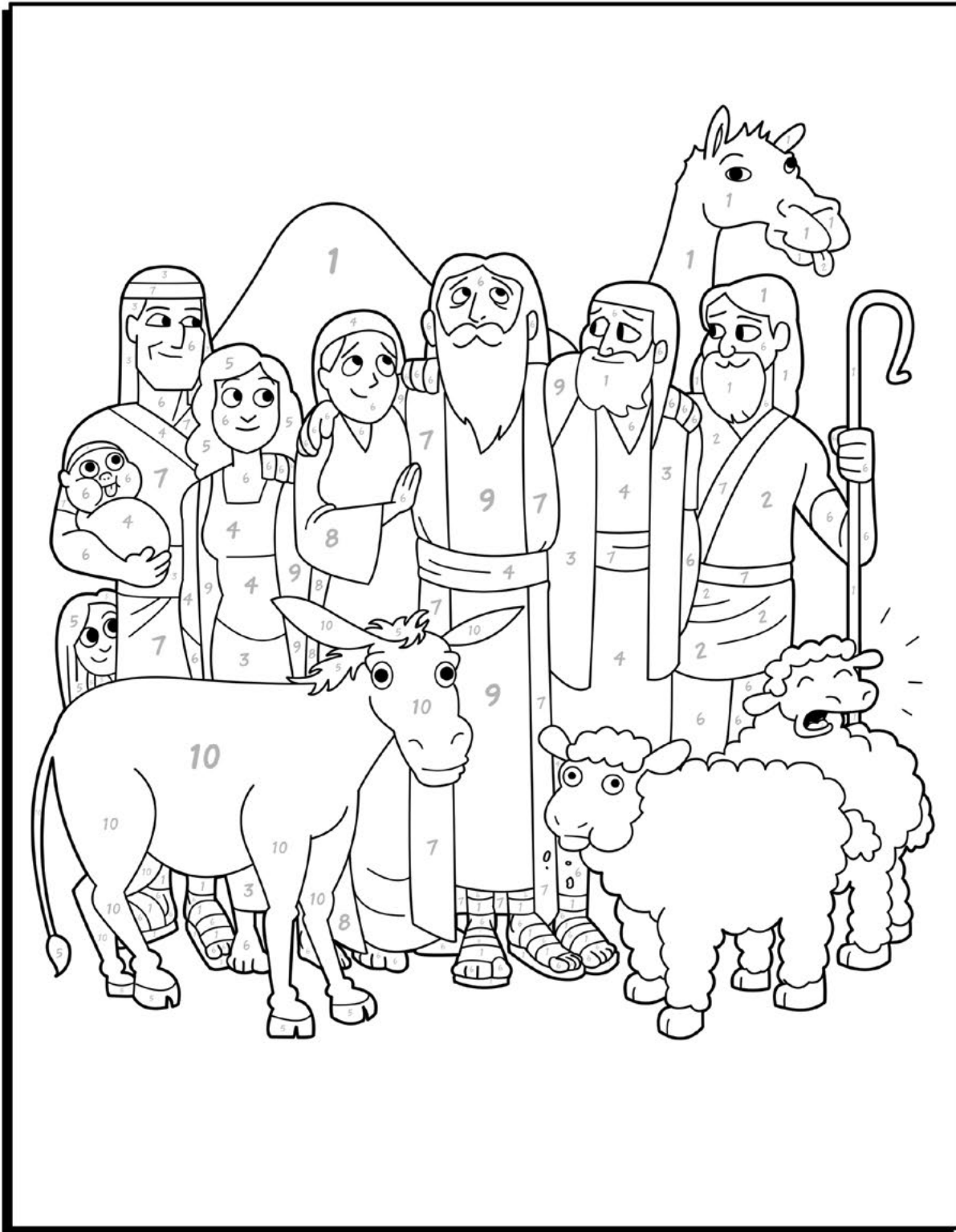

Job gets all his fortune restored.

Job 42: 17-17

Color by Numbers!

1 = Light blue
2 = Yellow

3 = Skin tone
4 = Green

5 = Red
6 = Purple

7 = Gray
8 = Brown

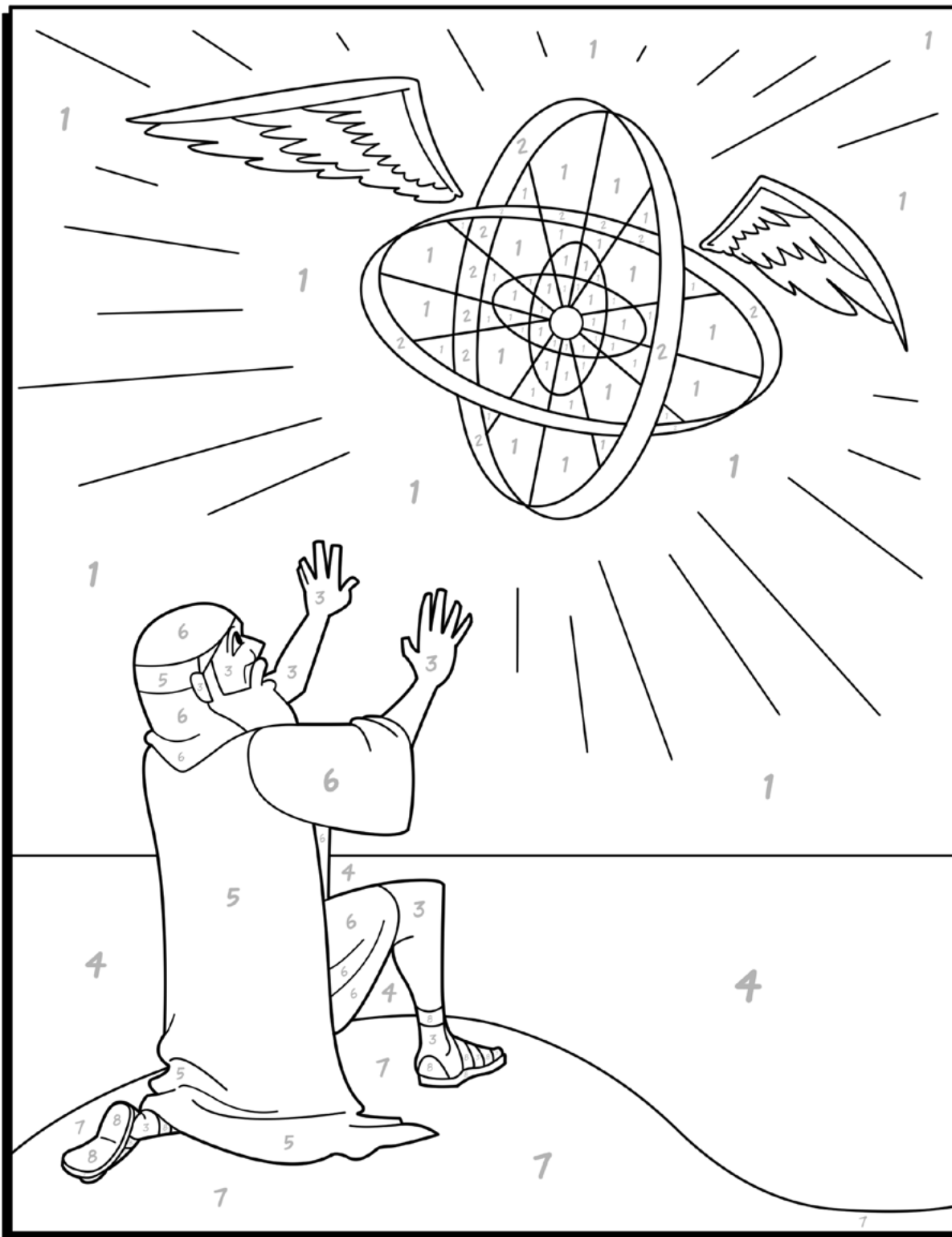

Ezekiel sees the wheel in the air.

Ezekiel 1

Color by Numbers!

1 = Red

3 = Yellow

5 = Green

7 = Blue

9 = Black

2 = Orange

4 = Purple

6 = Skin tone

8 = Brown

10 = Gray

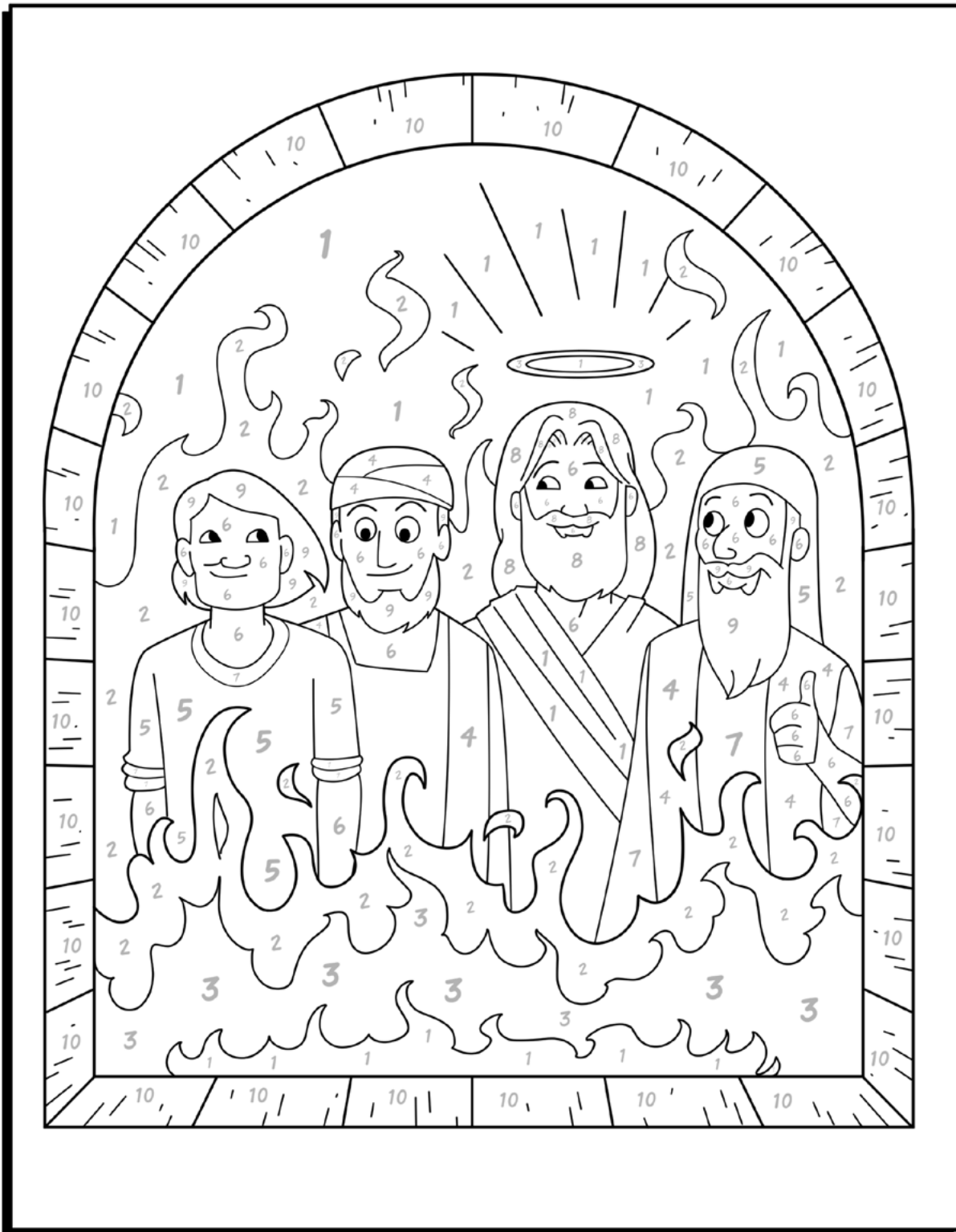

Shadrach, Meshach, and Abednego
escape the fiery furnace.

Daniel 3

Color by Numbers!

1 = Light blue
2 = Yellow

3 = Orange
4 = Purple

5 = Skin tone
6 = Gray

7 = Brown
8 = Black

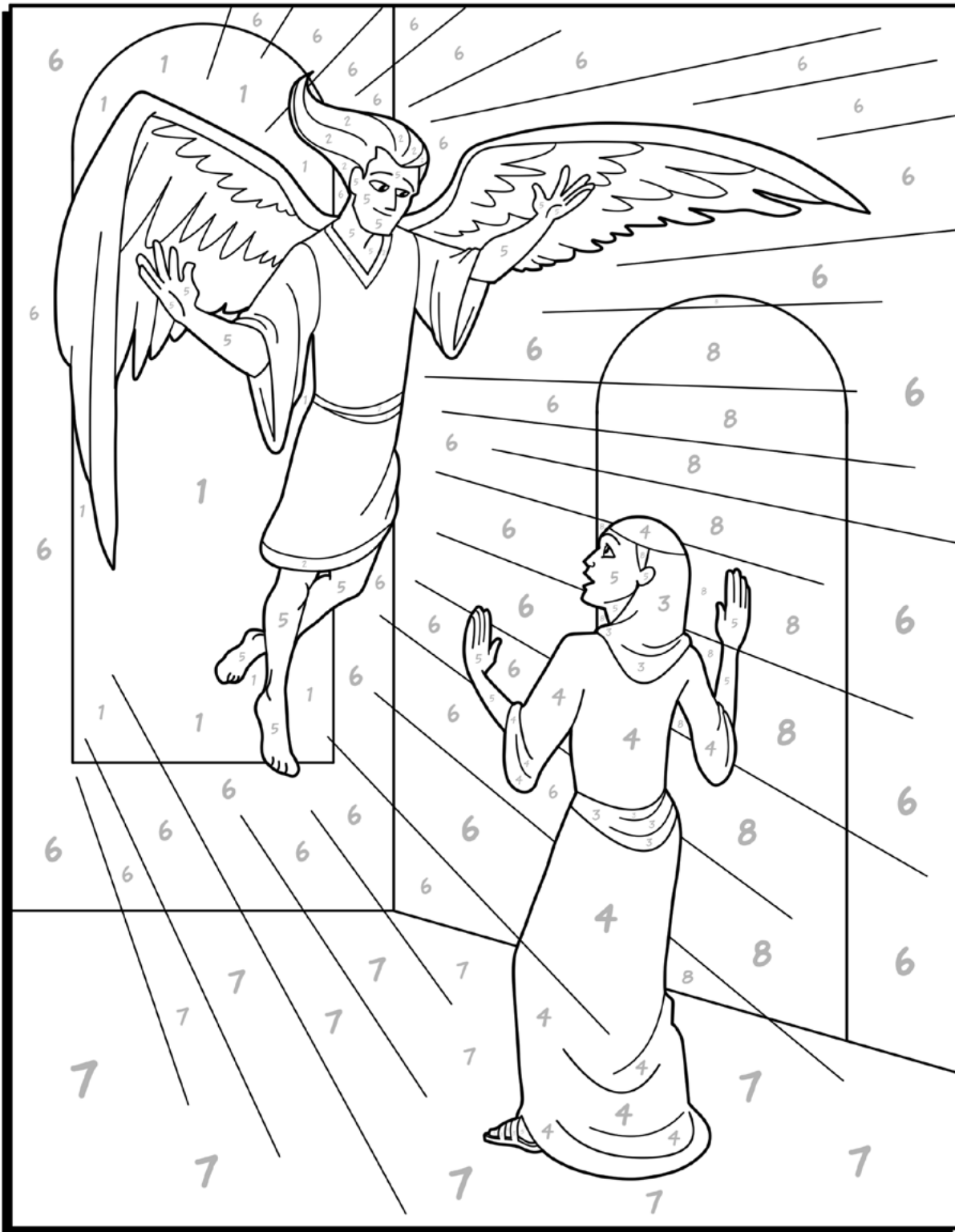

The angel Gabriel visits Mary.

Luke 1: 26-38

Color by Numbers!

1 = Blue

3 = Light blue

5 = Orange

7 = Brown

9 = Purple

2 = Yellow

4 = Red

6 = Skin tone

8 = Gray

10 = Green

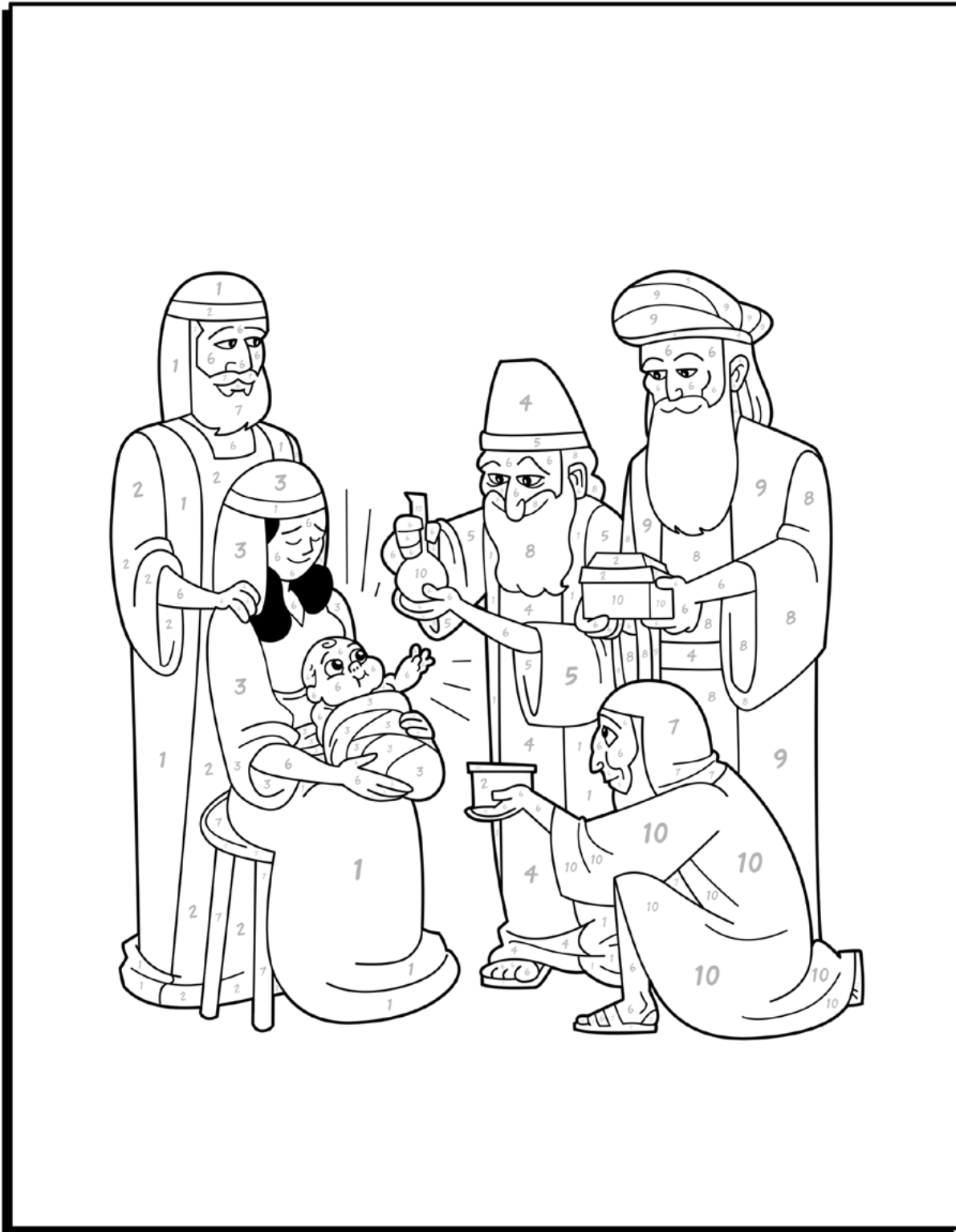

The wise men see Jesus.

Matthew 2

Color by Numbers!

1 = Gray

3 = Black

5 = Red

7 = Orange

9 = Green

2 = Brown

4 = Skin tone

6 = Dark Blue

8 = Purple

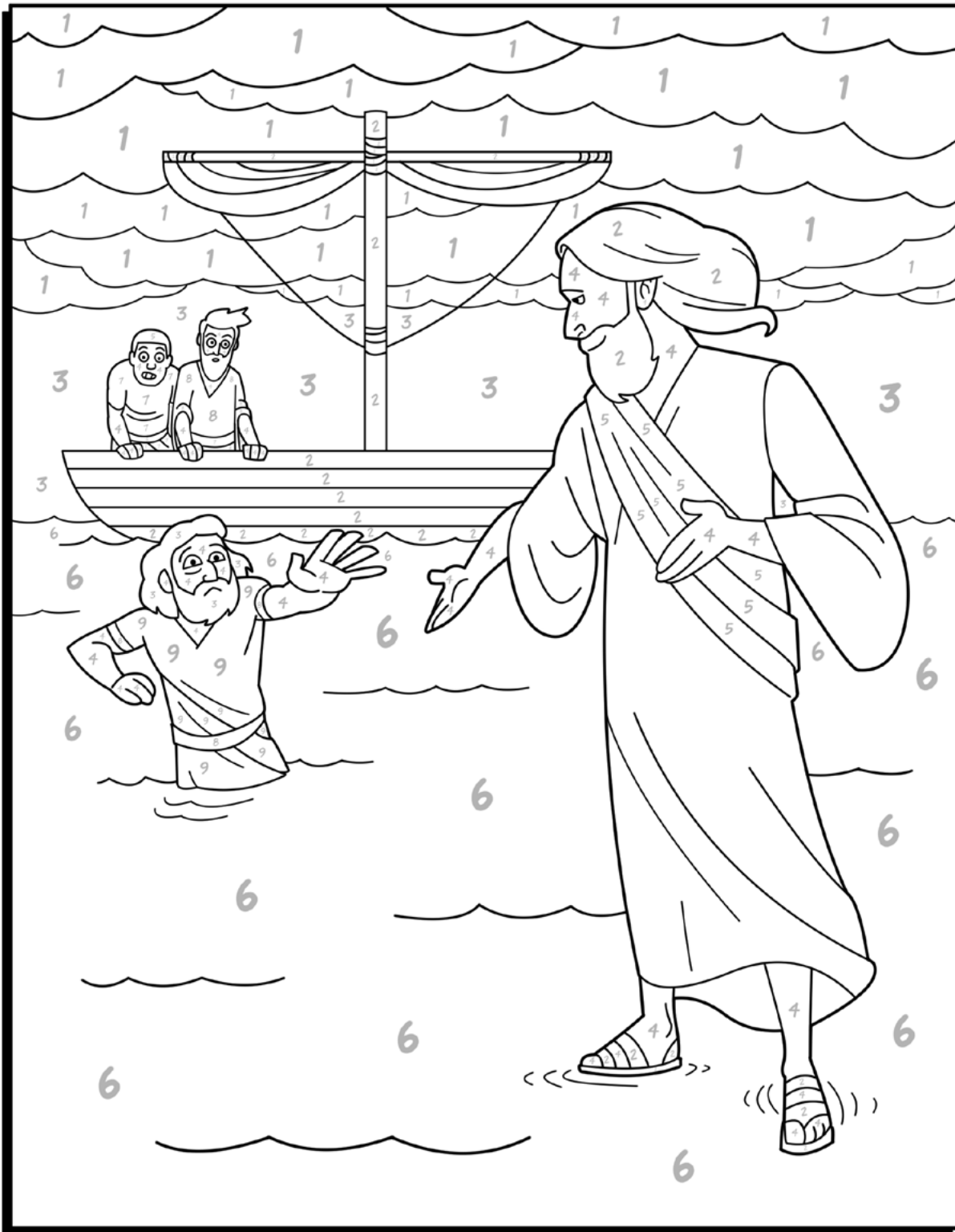

Jesus walks on water.

Matthew 14: 22-33

Color by Numbers!

1 = Brown
2 = Black

3 = Red
4 = Green

5 = Light blue
6 = Skin tone

7 = Purple
8 = Orange



Jesus heals the paralytic.

Mark 2

Color by Numbers!

1 = Brown

2 = Skin tone

3 = Red

4 = Purple

5 = Green

6 = Light blue

7 = Black

8 = Orange



Jesus loves the little children.

Luke 18

COLORING PAGES



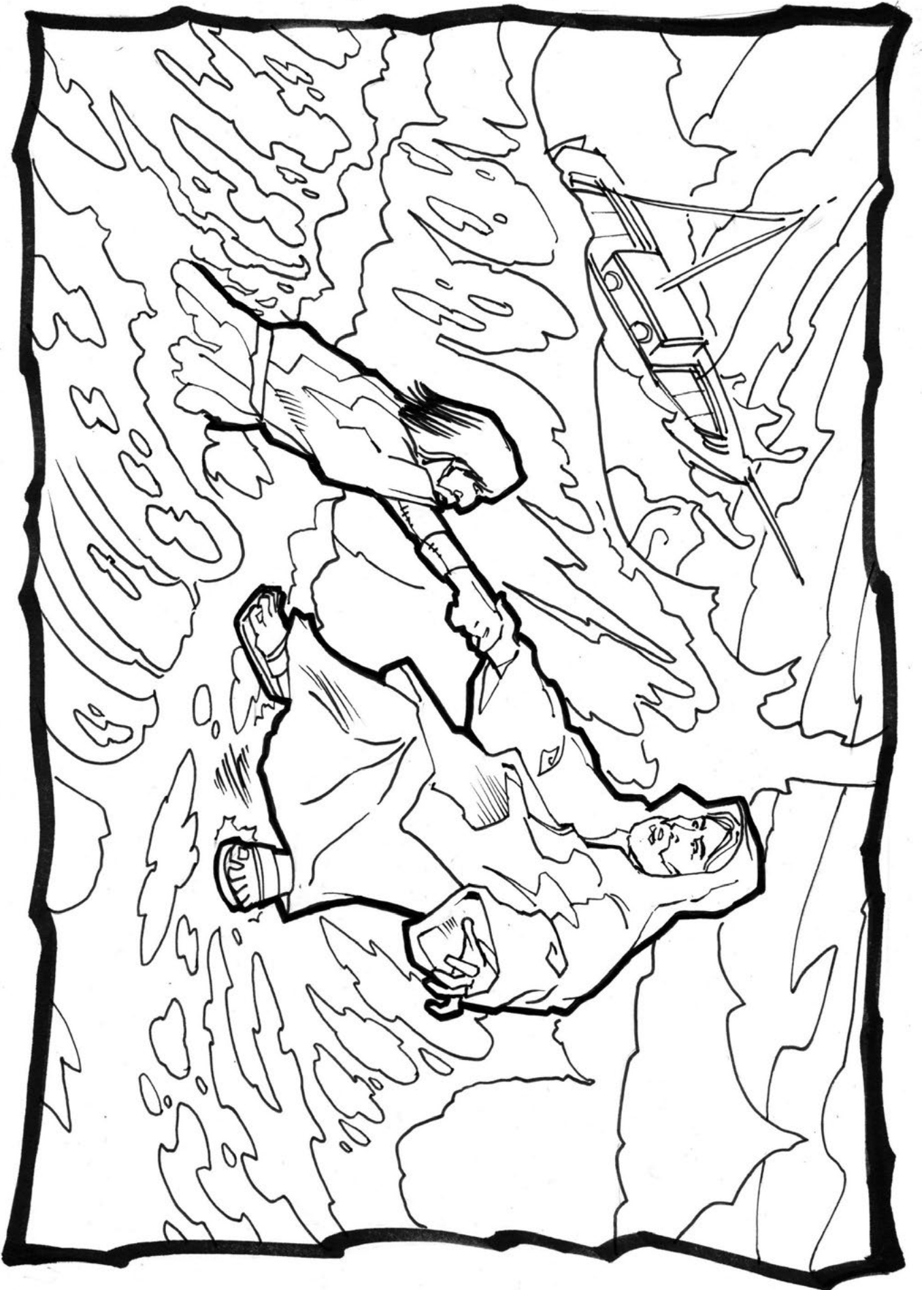

MATTHEW 14:22-33 And when the disciples saw Him walking on the sea, they were terrified! Jesus said to them, "Take courage! I AM! Stop being afraid!"



MATTHEW 5:39-44 If anyone strikes you on the right cheek, turn to him the other one, too. Love your enemies.



LUKE 12:16-21 The one who continues to hoard possessions
for himself is not rich in his relation to God.



LUKE 10:38-42 "Martha, Martha, you are troubled about many things. Mary has chosen the good portion, which shall not be taken away from her."



JOHN 8:1-7 "Let him who is without sin among you be the first to throw a stone at her."



MATTHEW 8:5-13 "I tell you truly, I have not found so much faith as this with anyone, even in Israel."



LUKE 7:36-48 A woman who was very sorry for the things she had done, wet Jesus' feet with expensive perfume and her tears. Then she kissed them and wiped them with her hair.

MARK 5:25-29 The bleeding lady is heal just by touching Jesus' clothes!

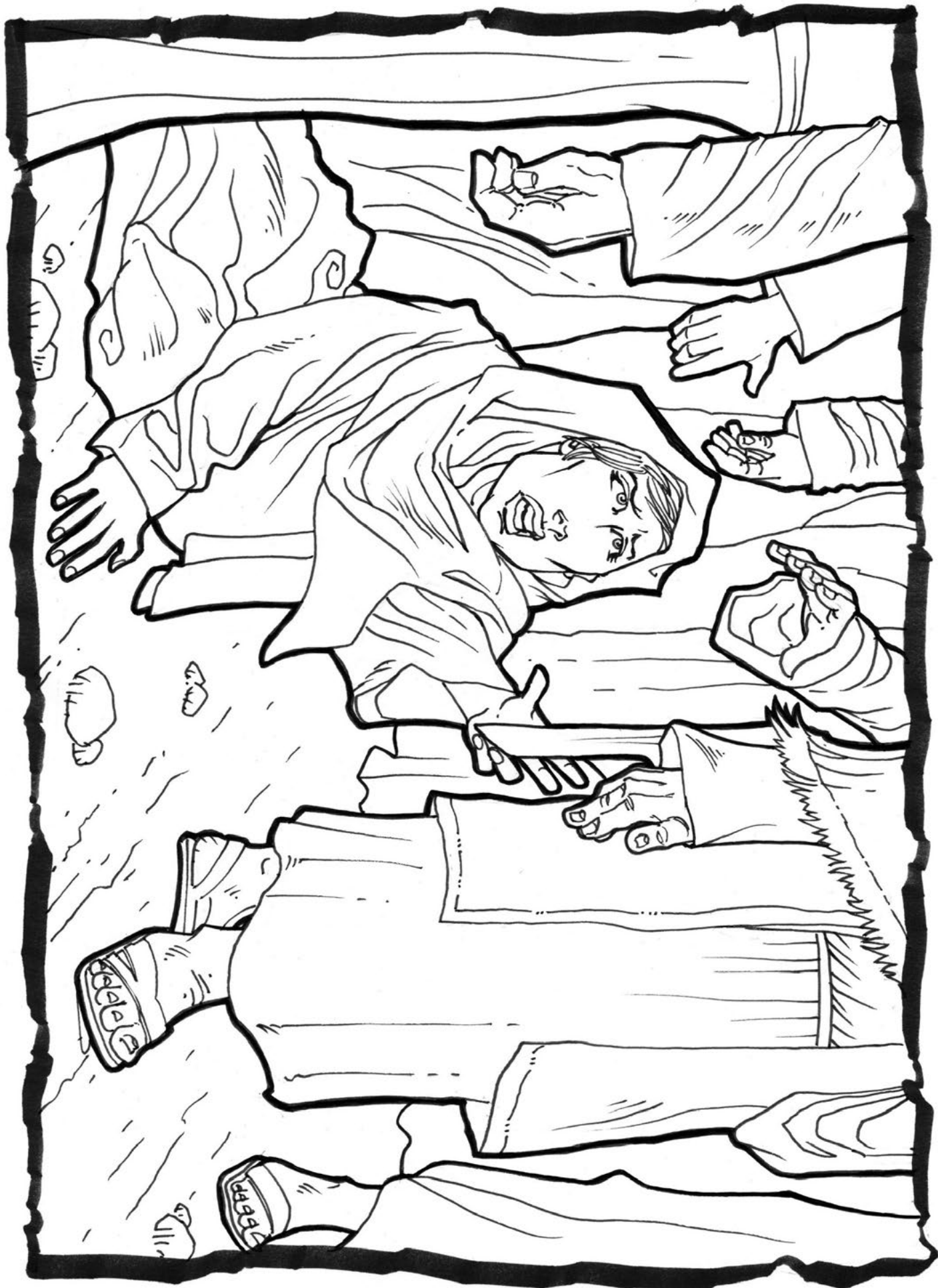

MATTHEW 8:23-27 Jesus commands the raging storm to stop and it does!





JOHN 6:1-14 Jesus performs a miracle and feeds a huge crowd with only a few loaves of bread and a few small fish!



LUKE 19:1-10 Because of the crowd, Zacchaeus the tax collector was too small to see Jesus so he climbed a tree. When Jesus saw him there he told him to come down so he could stay at his house!

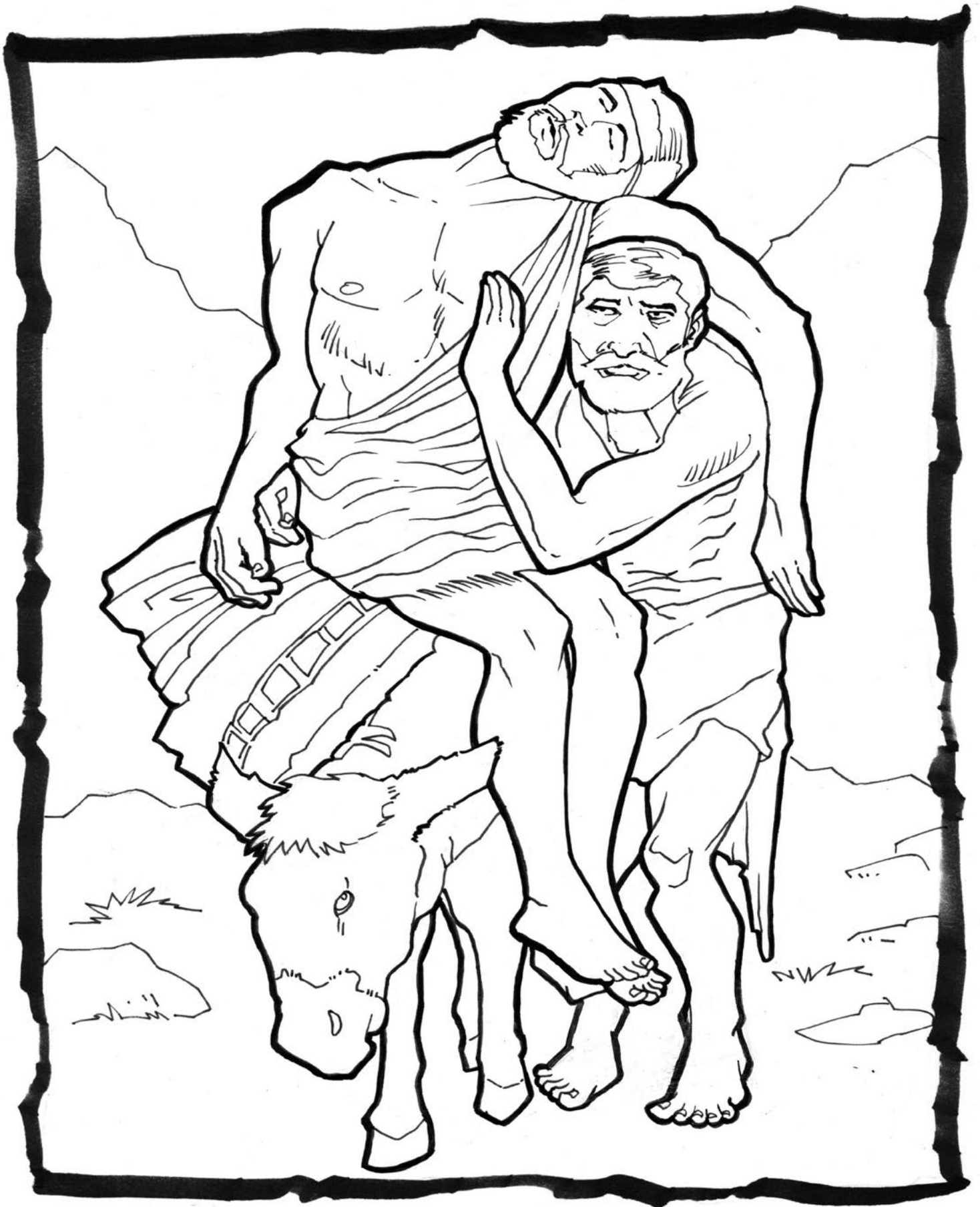

LUKE 10:30-35 Jesus told a story about a man from Samaria who was the only one to help the beaten man on the side of the road.

THE ARMOR OF GOD

EPHESIANS

6:11-18

Helmet of Salvation

Breastplate of
Righteousness

Sword of the
Spirit

The Belt
of Truth

The Shield of Faith

Shod your feet
In Preparation





THE TEN COMMANDMENTS - EXODUS 20



THE LORD'S PRAYER - MATTHEW 6:9-13



THE MIRACLES OF JESUS - LUKE 8:41-56

Jesus raises Jarius' 12 year old daughter from the dead.

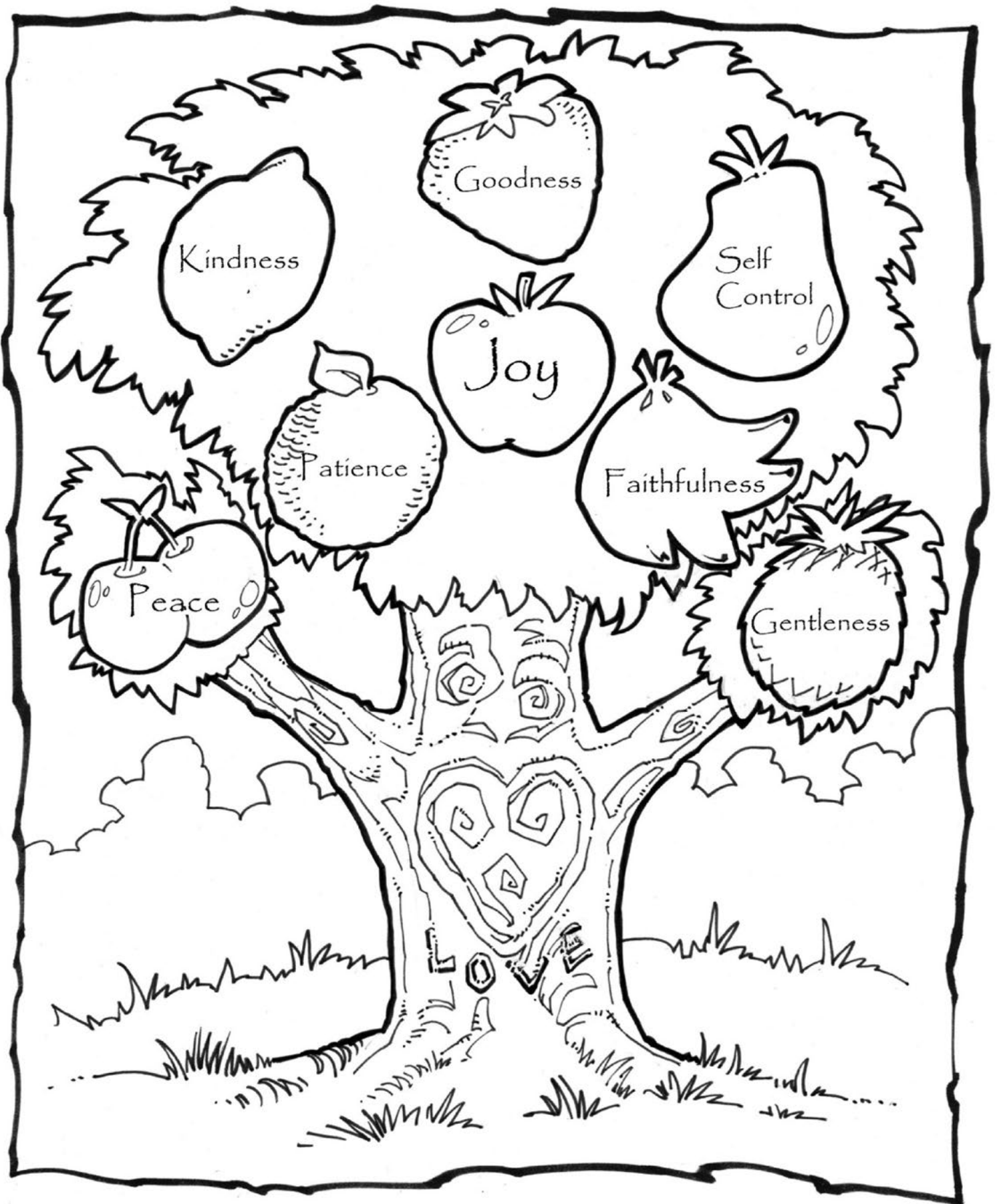

THE FRUITS OF THE SPIRIT - GALATIANS 5:22-23



JOSHUA 6 Rahab hid Joshua's spies from the enemy when they went to scout the city of Jericho.

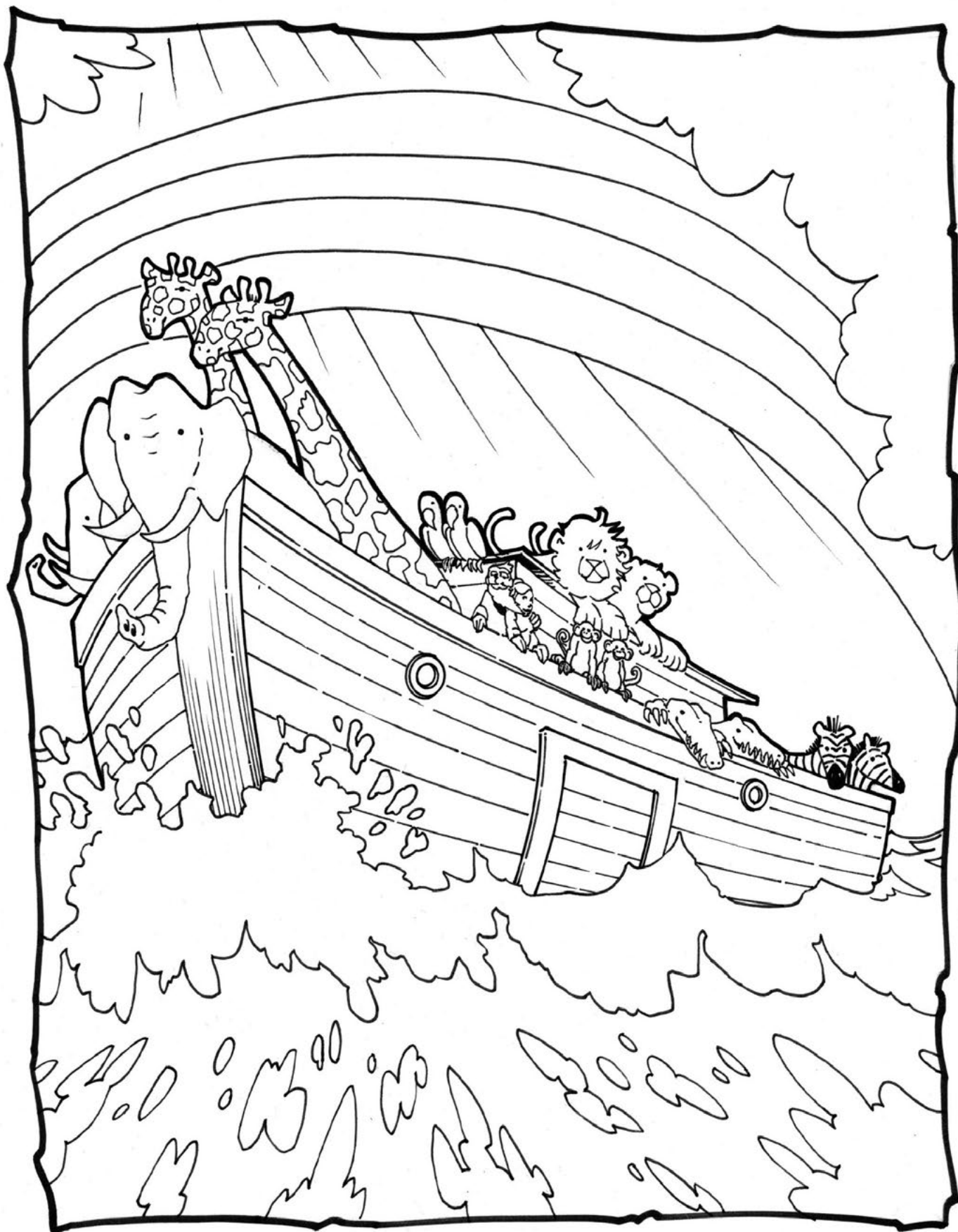

GENESIS 6-9 When Noah saw the sunshine and the rainbow he knew it was a message from God that he and his family would be safe.



RUTH 1-4 Old Naomi had no place to live. When her daughter Ruth said she could live with her, God blessed her with a husband.

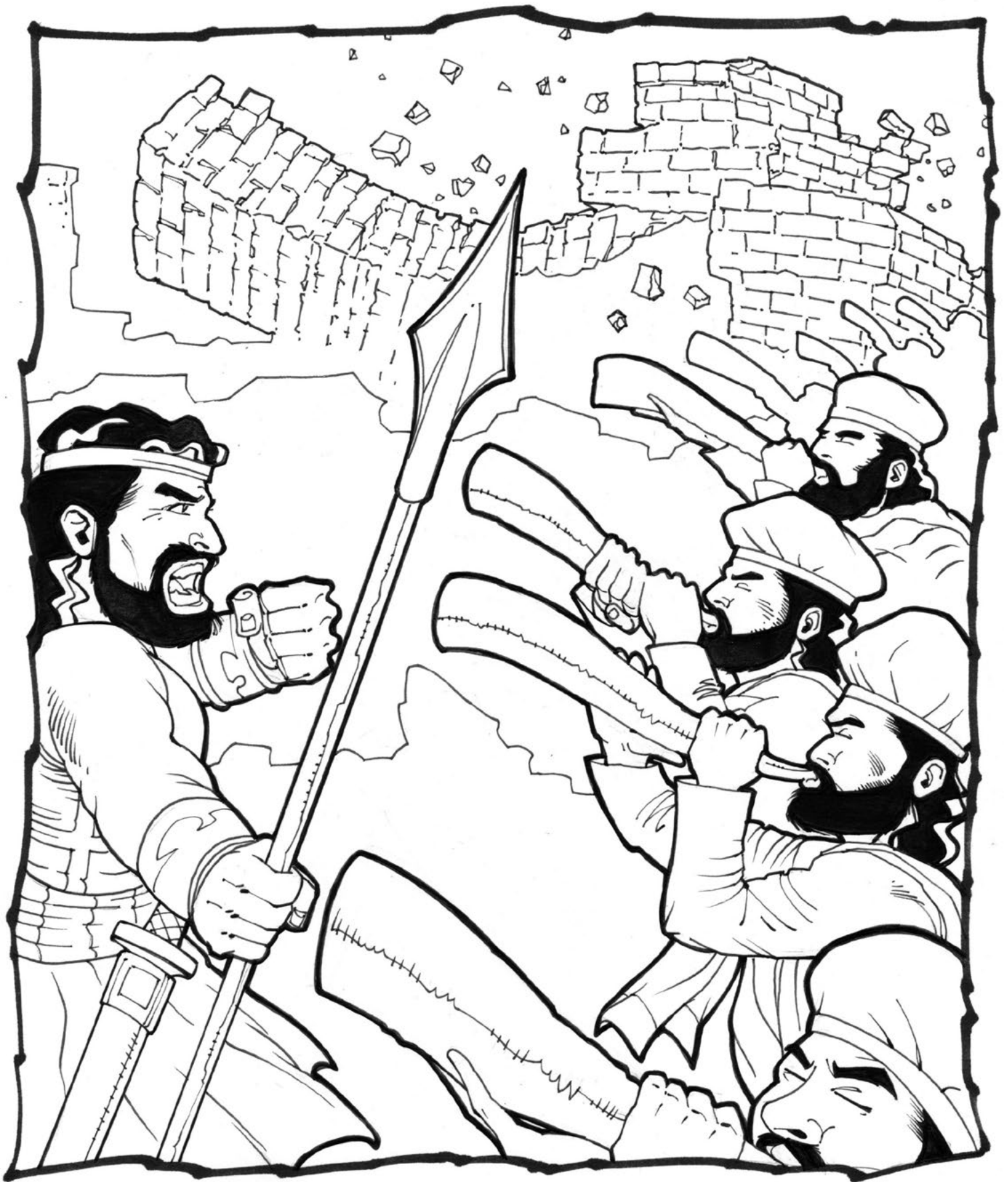

JOSHUA 6:1-20 When Joshua gave the command, his followers blew their trumpets and the walls of Jericho came crashing down.



JONAH 1-3 Jonah didn't want to go to Ninevah when God told him to. So God had a big fish swallow him and take him there.



EXODUS 3 God had Moses go up on the mountain
and He spoke to him from a burning bush.

MEMORY VERSE POSTERS



for **GOD** *SO LOVED* THE **WORLD**



THAT HE
GAVE HIS



ONE AND ONLY SON

THAT WHOEVER **BELIEVES**

IN **HIM** SHALL **NOT**

PERISH

BUT HAVE
ETERNAL *life.*

FOR **GOD** DID NOT SEND HIS

SON INTO THE **WORLD** TO

CONDEMN THE **WORLD**

BUT TO **SAVE** THE **WORLD**

through **HIM.**

- **JOHN 3:16-17**

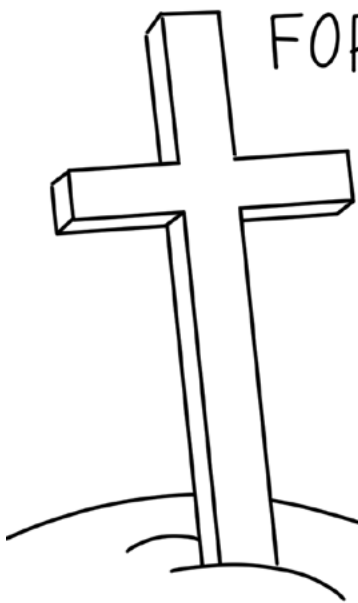

FOR
ALL
HAVE
SINNED

AND FALL SHORT OF
the

GLORY
OF
GOD

-ROMANS 3:23



FOR the WAGES
of SIN IS
DEATH



but the
GIFT of GOD
IS

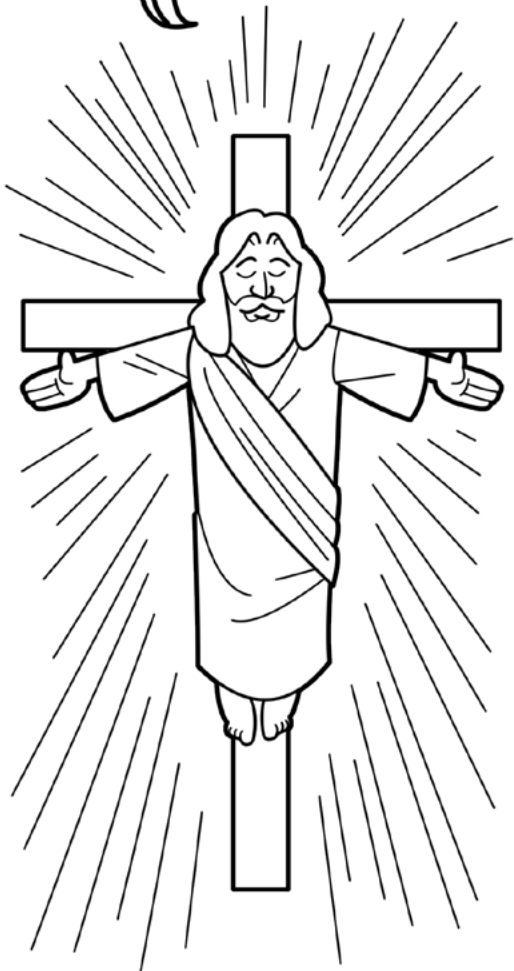

ETERNAL
LIFE
in CHRIST
JESUS
OUR
LORD.

-ROMANS 6:23

Here I am!

I STAND AT THE

DOOR

AND

KNOCK.

If ANYONE

HEARS my VOICE

and

the

OPENS DOOR,

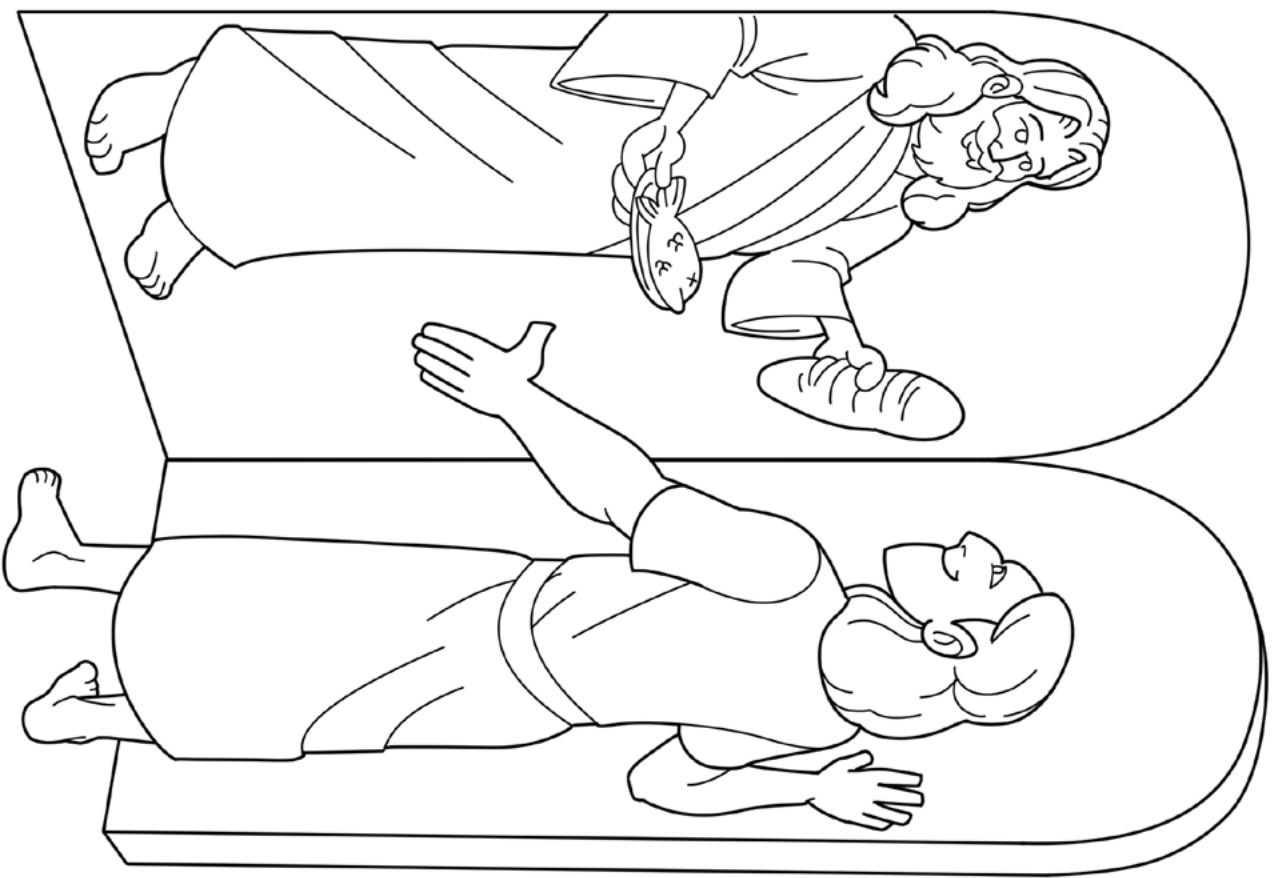

I WILL

I COME IN

and EAT

With him,

and HE

With ME.

-Revelation 3:20

Jesus
answered,

I AM

the

Way

and
the

TRUTH

and
the

LIFE.

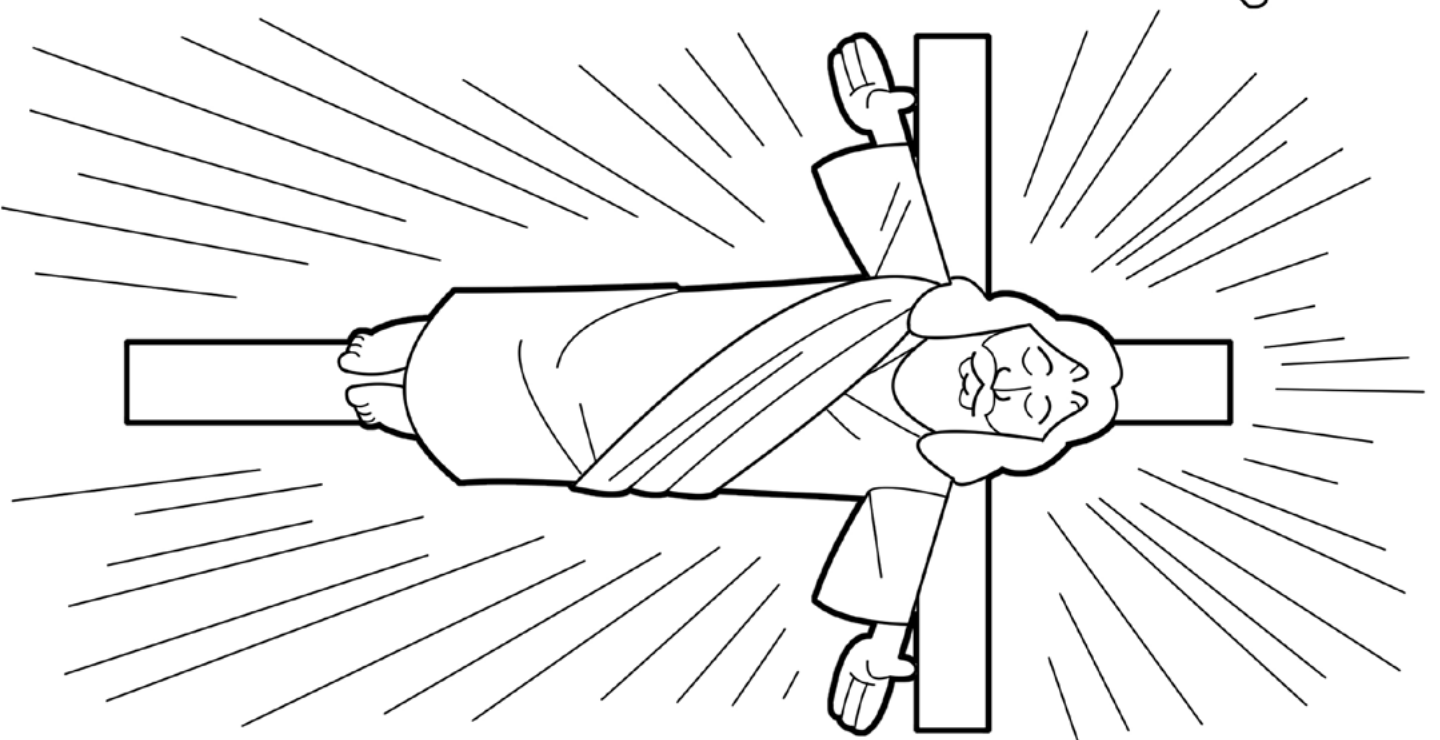

NO ONE

comes to

the

FATHER

EXCEPT

through

ME.

-John

14:6



FOR I AM CONVINCED THAT
 NEITHER **DEATH** NOR LIFE,
 NEITHER **ANGELS** NOR **DEMONS**,
 NEITHER the **Present** NOR

THE **FUTURE**
 NOR ANY **POWERS**,
 NEITHER

*
 NOR
**ANY-
 THING** IN

WEIGHT NOR
DEPTH

ALL CREATION



WILL BE ABLE TO SEPARATE US
 From the **LOVE** of **GOD**
 that is in **CHRIST**



JESUS OUR
LORD!



-ROMANS 8:38-39

COME *to* **ME**
ALL YOU WHO ARE **WEARY** AND **BURDENED**,
AND I WILL GIVE YOU **REST**. TAKE MY **YOKE**
UPON YOU AND **LEARN** FROM **ME**,
FOR **I** AM *gentle* AND **HUMBLE** IN **HEART**,

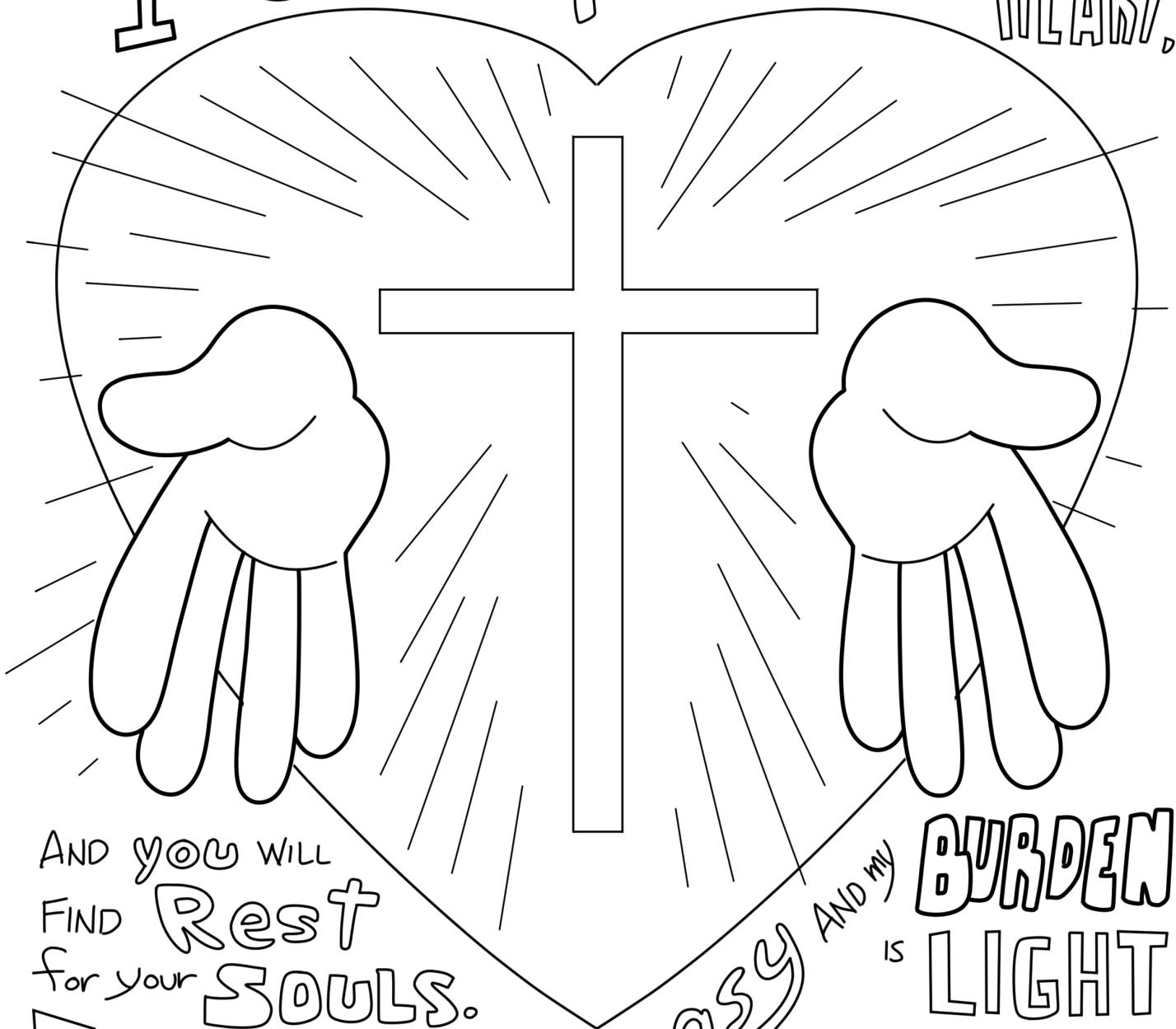

AND YOU WILL
FIND **Rest**
FOR YOUR **SOULS**.

FOR MY **YOKE** IS *easy*

AND MY **BURDEN**
IS **LIGHT**

— Matthew 11:28-30

THE LORD

IS MY Light

AND MY

SALVATION

- WHOM SHALL I FEAR?

THE LORD IS THE

STRONGHOLD

OF MY LIFE

- OF WHOM SHALL I BE

AFRAID?

- PSALM 27:1



Delight ^{YOURSELF} ^{IN THE} LORD

AND HE WILL GIVE YOU the Desires
of your HEART.



COMMIT
YOUR WAY
to the LORD,
Trust ^{IN} HIM

AND HE WILL DO THIS.

- Psalm 37: 4,5

TRUST IN THE **LORD**

WITH **ALL** your **heart**

AND LEAN **NOT** ON YOUR **OWN**

UNDERSTANDING

IN **ALL** of your **WAYS**

ACKNOWLEDGE HIM

AND **HE** WILL MAKE

YOUR **paths**

STRAIGHT.

- **PROVERBS 3:5,6**



I CAN DO ALL

THINGS
through

CHRIST

WHO

STRENGTHENS
ME.

- PHILIPPIANS 4:13



WHATEVER you DO

WORK AT IT WITH ALL YOUR HEART

AS WORKING FOR THE

LORD,

NOT FOR

MEN



— COLOSSIANS
3:23

SUBMIT
YOURSELVES.

THEN, to **GOD.**

RESIST

THE

DEVIL

AND

HE

WILL

FLY

from
you.

- JAMES 4:7

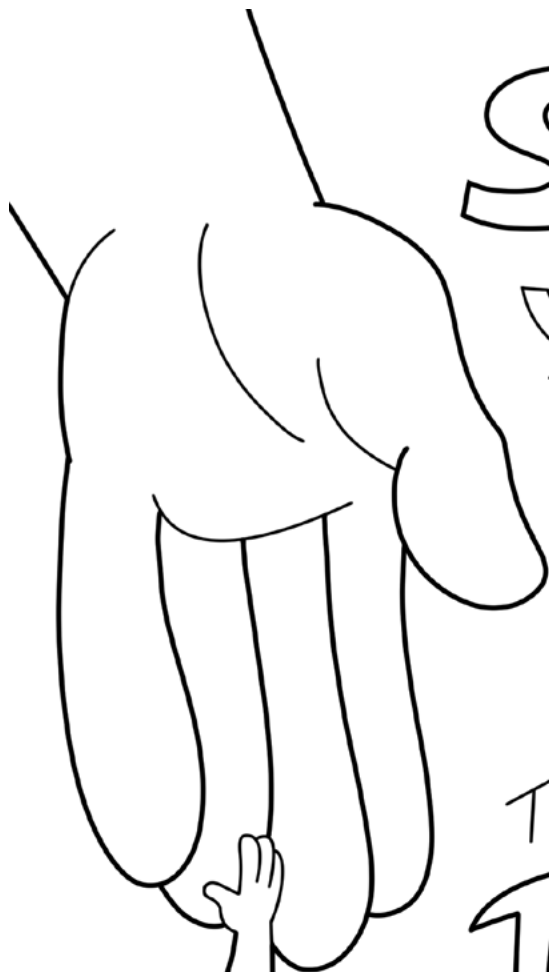

Give

THANKS

in ALL

CIRCUM

STANCES

FOR THIS IS

GOD'S WILL

for *you* in

CHRIST JESUS.

- 1 THESSALONIANS 5:18



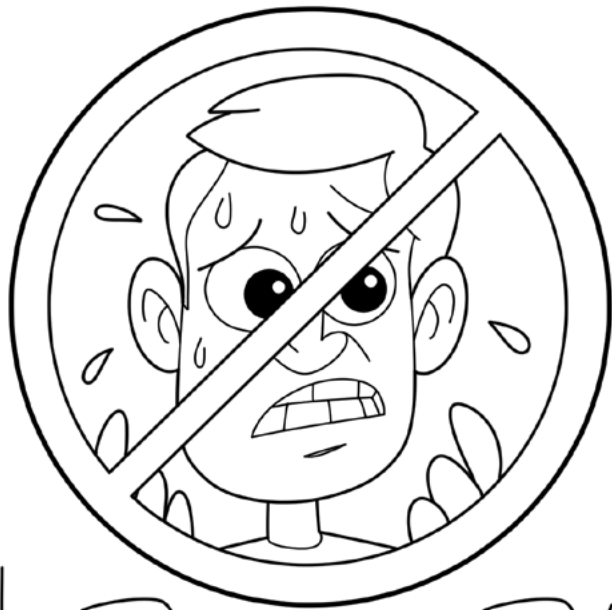

DO NOT BE
ANXIOUS
ABOUT ANYTHING
BUT IN **EVERY** THING,

by *Prayer & Petition,*

with **THANKS -
GIVING,**

Present your

Requests to **GOD.**

AND the **PEACE** of **GOD,** WHICH
transcends **ALL** Understanding

WILL **GUARD** your **HEARTS** AND your **MINDS**

in **CHRIST JESUS**

-Philippians
4:6,7



JESUS CHRIST

IS THE SAME Yesterday
AND Today AND For Ever

-HEBREWS

13:8

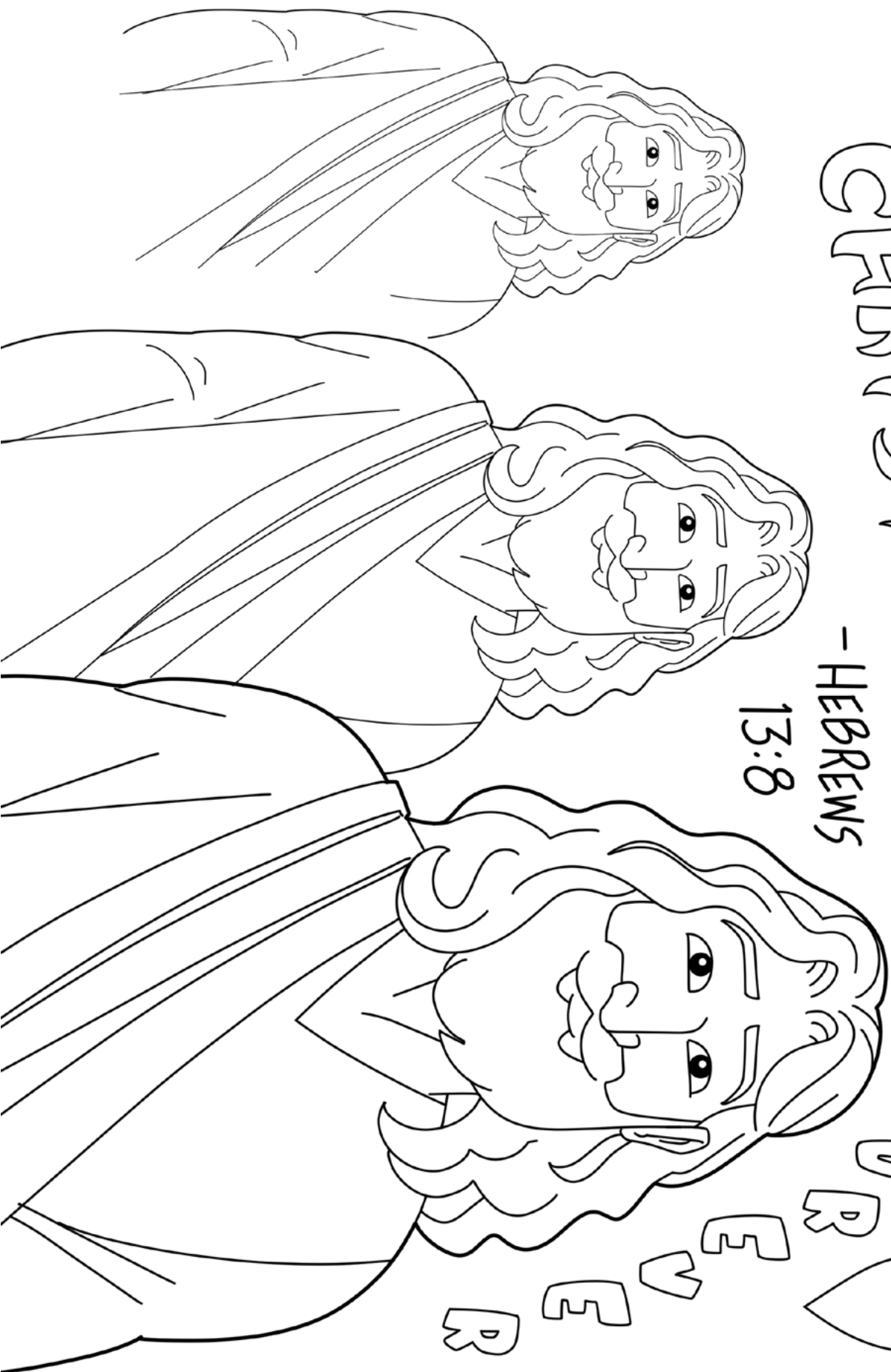

FOR IT IS BY
GRACE

YOU HAVE BEEN
SAVED

through **Faith**

-AND THIS NOT FROM
YOURSELVES,

IT IS

the **gift**

OF

**DOGG
DOGG
D**

*



*
NOT
by **WORKS**
so that **NO ONE**
CAN **BOAST.**

-Ephesians 2:8,9

Therefore,

IF ANYONE

IS IN

CHRIST

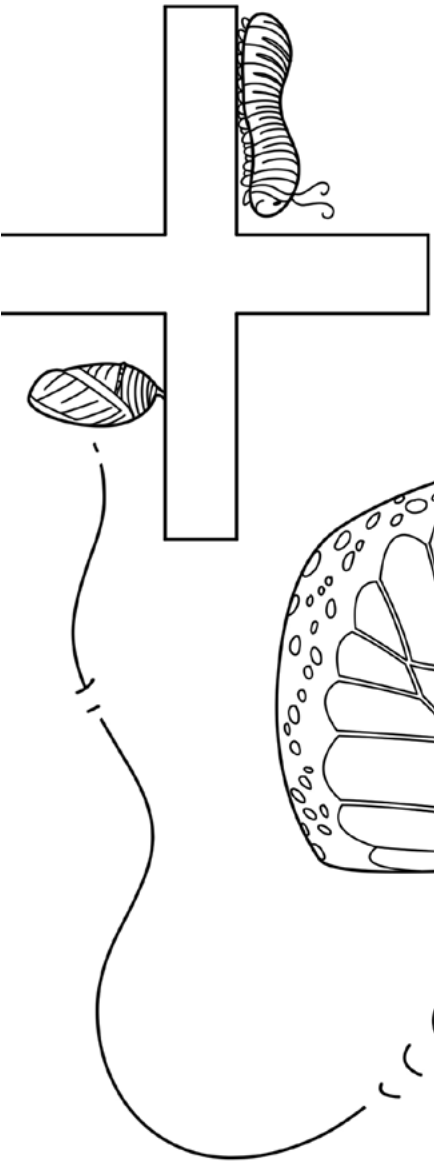

HE IS A

NEW

CREATION

THE OLD

has gone,

the NEW

HAS

COME!

- 2 CORINTHIANS 5: 17

AND WE KNOW THAT IN ALL THINGS **GOD** WORKS for the good of those who **LOVE HIM** WHO



have been **CALLED** according to **HIS** **Purpose.**

-ROMANS 8:28

EVEN YOUTHS GROW TIRED & WEARY

AND YOUNG MEN STUMBLE + FALL; BUT THOSE

WHO HOPE IN THE LORD WILL RENEW

their STRENGTH. THEY WILL



SOAR

Wings

LIKE

EAGLES;

THEY WILL

RUN

AND NOT

GROW WEARY

THEY WILL WALK

AND NOT BE FAINT.

- ISAIAH 40:30-31

